

CAT-40 V-FLANGE SHELL MILL HOLDERS

SHELL MILL HOLDERS

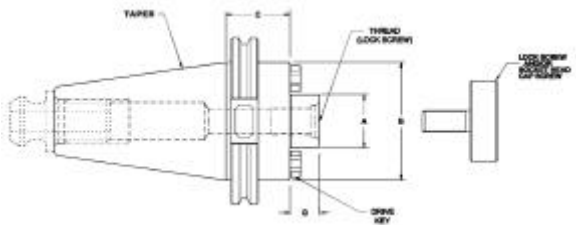

A Pilot Dia	B Dia.	C Proj.	G	Brand	Part Number	Price Each	Drive Key	Screw Thread	Lock Screw	Arbor Screw	Code
1/2" 0.500	1.38	1.75	0.57	Lyndex	C40-50SM175-L	\$129.00	1/4"	1/4" - 28	-	A1/4-28	B
	1.75	1.38	-	Kingston	C40-50SM138-K	\$81.40	-	-	-	-	D
	1.75	1.38	-	Collis	C40-50SM138-C	\$85.68	64750	1/4" - 28	-	64830	C
	1.75	3.50	-	Kingston	C40-50SM350-K	\$90.69	-	-	-	-	D
3/4" 0.750	1.75	1.37	0.68	Domestic	C40-75SM137-A	\$93.80	BDK-312	3/8" - 24	B5002	B5002	B
	1.75	1.38	-	Collis	C40-75SM138-C	\$85.68	64751	3/8" - 24	-	64831	C
	1.75	1.38	0.68	Parlec	C40-75SM138-P	\$98.00	75KY	3/8" - 24	-	028-192	B
	-	1.50	-	Kingston	C40-75SM150-K	\$81.60	-	-	-	-	D
	1.75	1.50	0.68	Parlec	C40-75SM150-P	\$89.60	75KY	3/8" - 24	-	028-192	B
	1.75	3.50	-	Kingston	C40-75SM350-K	\$90.69	-	-	-	-	D
	1.75	3.50	-	Collis	C40-75SM350-C	\$110.32	64751	3/8" - 24	-	64831	C
	-	4.00	-	Kingston	C40-75SM400-K	\$94.69	-	-	-	-	D
	1.75	4.00	0.68	Domestic	C40-75SM400-A	\$115.50	BDK-312	3/8" - 24	B5002	B5002	B
	1.75	4.00	0.68	Parlec	C40-75SM400-P	\$109.20	75KY	3/8" - 24	-	028-192	B
1.75	6.00	-	Kingston	C40-75SM600-K	\$110.69	-	-	-	-	D	
2.00	1.75	0.67	Lyndex	C40-75SM175-L	\$129.00	5/16"	3/8" - 24	-	A3/8-24	B	
2.00	4.00	0.67	Lyndex	C40-75SM400-L	\$159.00	5/16"	3/8" - 24	-	A3/8-24	B	
1" 1.000	2.19	1.00	-	Collis	C40-10SM100-C	\$85.68	64752	1/2" - 20	-	64832	C
	2.19	2.06	-	Collis	C40-10SM206-C	\$85.68	64752	1/2" - 20	-	-	C
	2.19	2.06	0.68	Domestic	C40-10SM206-A	\$93.80	BDK-375	1/2" - 20	-	B5003	B
	2.19	2.50	-	Collis	C40-10SM250-C	\$89.46	64752	1/2" - 20	-	64832	C
	2.19	4.00	-	Kingston	C40-10SM400-K	\$94.69	-	-	-	-	D
	2.19	4.00	-	Collis	C40-10SM400-C	\$110.32	64752	1/2" - 20	-	64832	C
	2.19	4.00	0.68	Domestic	C40-10SM400-A	\$115.50	BDK-375	1/2" - 20	-	B5003	B
	2.19	6.00	-	Kingston	C40-10SM600-K	\$130.50	-	-	-	-	D
	2.25	1.00	0.68	Parlec	C40-10SM100-P	\$98.00	10KY	1/2" - 20	10LS	028-188	B
	-	1.15	-	Kingston	C40-10SM115-K	\$81.60	-	-	-	-	D
	-	1.15	-	USST*	C40-10SM115-U	\$80.00	-	-	-	-	D
	2.25	4.00	0.68	Parlec	C40-10SM400-P	\$114.80	10KY	1/2" - 20	-	028-188	B
	-	2.00	-	Kingston	C40-10SM200-K	\$81.60	-	-	-	-	D
	2.25	2.00	0.68	Parlec	C40-10SM200-P	\$89.60	10KY	1/2" - 20	10LS	028-188	B
2.25	2.00	0.68	USST*	C40-10SM200-U	\$80.00	10KY	1/2" - 20	10LS	-	D	
2.38	1.75	0.67	Lyndex	C40-10SM175-L	\$129.00	3/8"	1/2" - 20	-	A1/2-20	B	
2.38	4.00	0.67	Lyndex	C40-10SM400-L	\$159.00	3/8"	1/2" - 20	-	A1/2-20	B	
1-1/4" 1.250	2.75	1.62	-	Collis	C40-12SM162-C	\$89.46	64753	5/8" - 18	-	64833	C
	2.75	1.62	0.68	Parlec	C40-12SM162-P	\$125.30	12KY	5/8" - 18	-	028-193	B
	2.75	2.12	-	Collis	C40-12SM212-C	\$89.46	-	-	-	-	C
	2.75	2.25	0.68	Parlec	C40-12SM225-P	\$93.80	12KY	5/8" - 18	12LS	028-193	B
	2.75	4.00	-	Collis	C40-12SM400-C	\$110.32	64753	5/8" - 18	-	64833	C
	2.75	4.00	0.68	Parlec	C40-12SM400-P	\$114.80	12KY	5/8" - 18	12LS	028-193	B
	2.88	1.62	-	Kingston	C40-12SM162-K	\$81.60	-	-	-	-	D
	2.88	2.00	0.67	Lyndex	C40-12SM200-L	\$134.00	1/2"	5/8" - 18	-	A5/8-18	B
	2.88	2.12	-	Kingston	C40-12SM212-K	\$81.60	-	-	-	-	D
	2.88	2.12	0.68	Domestic	C40-12SM212-A	\$93.80	BDK-500	5/8" - 18	B5004	B5004	B
2.88	2.50	-	Kingston	C40-12SM250-K	\$85.99	-	-	-	-	D	
2.88	4.00	-	Kingston	C40-12SM400-K	\$94.69	-	-	-	-	D	
2.88	4.00	0.68	Domestic	C40-12SM400-A	\$140.25	BDK-500	5/8" - 18	B5004	B5004	B	
2.88	4.00	0.67	Lyndex	C40-12SM400-L	\$159.00	1/2"	5/8" - 18	-	A5/8-18	B	

*USST Toolholders are available while supplies last.

(Additional CAT-40 Shell Mill Holders are located on the following page)

Call Us Today For All Of Your Machine Tool Needs!

CAT-40 V-FLANGE SHELL MILL HOLDERS

SHELL MILL HOLDERS

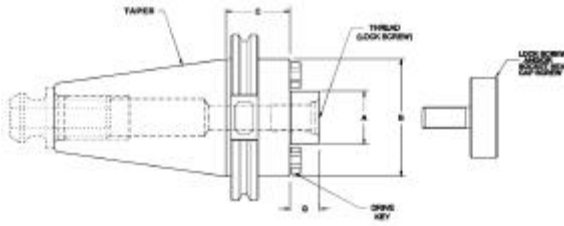

A Pilot Dia	B Dia.	C Proj.	G	Brand	Part Number	Price Each	Drive Key	Screw Thread	Lock Screw	Arbor Screw	Code
1-1/2" 1.500	3.38	1.62	-	Kingston	C40-15SM162-K	\$81.60	-	-	-	-	D
	3.38	2.50	-	Kingston	C40-15SM250-K	\$85.99	-	-	-	-	D
	3.38	4.00	-	Kingston	C40-15SM400-K	\$97.69	-	-	-	-	D
	3.62	1.62	-	Collis	C40-15SM162-C	\$92.40	64754	3/4" - 16	-	64834	C
	3.62	2.40	-	Collis	C40-15SM240-C	\$92.40	64754	3/4" - 16	-	64834	C
	3.62	4.00	-	Collis	C40-15SM400-C	\$115.50	64754	3/4" - 16	-	64834	C
	3.75	2.40	0.94	Parlec	C40-15SM240-P	\$100.10	15KY	3/4" - 16	15LS	15LS	B
	3.75	4.00	0.94	Parlec	C40-15SM400-P	\$125.30	15KY	3/4" - 16	15LS	15LS	B
	3.80	2.00	0.93	Lyndex	C40-15SM200-L	\$139.00	5/8"	3/4" - 16	-	A3/4-16	B
	3.80	4.00	0.93	Lyndex	C40-15SM400-L	\$172.00	5/8"	3/4" - 16	-	A3/4-16	B
	3.81	2.41	0.94	Domestic	C40-15SM240-A	\$96.60	BDK-625	3/4" - 16	B5005	B5005	B
	3.81	4.00	0.94	Domestic	C40-15SM400-A	\$142.80	BDK-625	3/4" - 16	B5005	B5005	B

90° MILLING CUTTERS



- High Positive Design
- Free Cutting
- Excellent Chip Control
- Made in USA!



E

Description	Dia.	Shank Dia.	No. Of Teeth	Part Number	Price Each	Extra Screw	Torx Wrench
SHELL MILLS	2.00	0.75	4	TB-2000	\$173.00	SC-01	TX-20S \$5.00
	2.00	0.75	5	TB-2005	\$235.00	\$ 1.00	
	3.00	1.00	6	TB-3000	\$216.00	SC-02	
	4.00	1.25	7	TB-4000	\$292.00	\$ 1.00	

MILLING INSERTS

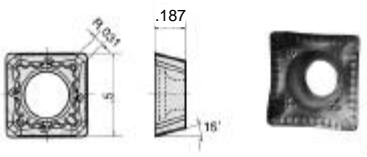

G

Material	Reference Number	Polished	Coated
For Aluminum, Copper, Brass	SDGT1204PDFR-AJ-TH10	US-820 \$ 9.80	-
For Mild Steel, Stainless Steel, Super Alloys	SDMT1204PDPR-ML-AH120	-	US-821 \$7.09
For Alloy Steels, Die Steels, Cast Iron	SDMT1204PDSR-MJ-AH120	-	US-822 \$7.09

POWER MILLING CHUCKS

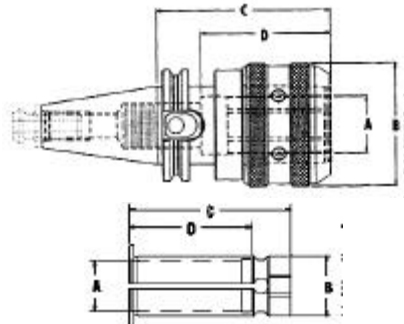

C

Bushings

Type	A	B	C	D	Part Number	Price Each
75MC	0.1875	0.75	2.00	1.375	75MCRB-188-P	\$40.50 each
	0.2500				75MCRB-250-P	
	0.3125				75MCRB-313-P	
	0.3750				75MCRB-375-P	
	0.5000				75MCRB-500-P	
	0.5625				75MCRB-563-P	
	0.6250				75MCRB-625-P	
12MC	0.1875	1.25	2.75	2.125	12MCRB-188-P	\$40.50 each
	0.2500				12MCRB-250-P	
	0.3125				12MCRB-313-P	
	0.3750				12MCRB-375-P	
	0.5000				12MCRB-500-P	
	0.5625				12MCRB-563-P	
	0.6250				12MCRB-625-P	
	0.7500				12MCRB-750-P	
	0.8750				12MCRB-875-P	
	1.0000				12MCRB-100-P	

Taper	A	B	C	D	Back Up Screw	Part Number	Price Each
CAT 40	0.75	2.19	3.64	2.24	Style 3	C40-75MC3-P	\$283.50
CAT 40	1.25	2.75	4.13	3	Style 1	C40-12MC4-P	\$297.90
CAT 50	0.75	2.19	3.96	2.24	Style 3	C50-75MC3-P	\$354.00
CAT 50	1.25	2.75	4.13	3	Style 2	C50-12MC4-P	\$366.00
CAT 50	1.25	2.75	6	3	Style 2	C50-12MC6-P	\$431.00
BT 40	0.75	2.19	3.64	2.24	Style 3	B40-75MC3-P	\$287.10
BT 40	1.25	2.75	4.44	3	Style 2	B40-12MC4-P	\$315.00

- FEATURES:**
- Constructed of alloy steel for long, durable service life.
 - Hardened to RC 56-60 for long service life.
 - Shiny taper with black oxide finish for accuracy and durability.
 - End mill socket T.I.R. ± 0.0002 .
 - Through-spindle coolant capability.

Call Us Or Visit Our Website For Our Complete Selection!

CAT-50 V-FLANGE SHELL MILL HOLDERS

SHELL MILL HOLDERS

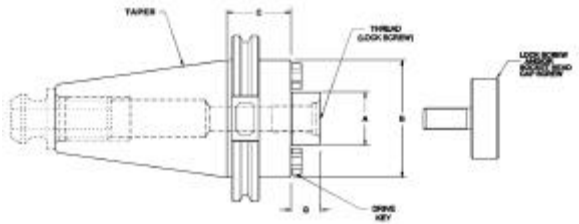

RETENTION KNOBS
are on
page 154-161



A Pilot Dia	B Dia.	C Proj.	G	Brand	Part Number	Price Each	Drive Key	Screw Thread	Lock Screw	Arbor Screw	Code	
1/2" 0.500	1.44	5.50	-	Kingston	C50-50SM550-K	\$130.69	-	-	-	-	D	
	1.56	1.50	-	Collis	C50-50SM150-C	\$111.79	64750	1/4" - 28	-	64830	C	
	1.56	3.50	-	Collis	C50-50SM350-C	\$130.41	64750	1/4" - 28	-	64830	C	
3/4" 0.750	1.75	1.50	-	Kingston	C50-75SM150-K	\$102.43	-	-	-	-	D	
	1.75	1.50	0.68	Parlec	C50-75SM150-P	\$106.40	75KY	3/8" - 24	-	028-192	B	
	1.75	3.50	-	Kingston	C50-75SM350-K	\$110.85	-	-	-	-	D	
	1.75	3.50	0.68	Domestic	C50-75SM350-A	\$132.30	BDK-312	3/8" - 24	B5002	B5002	B	
	1.75	3.50	0.68	Parlec	C50-75SM350-P	\$127.40	75KY	3/8" - 24	-	028-192	B	
	1.75	5.50	-	Kingston	C50-75SM550-K	\$130.50	-	-	-	-	D	
	1.75	5.50	0.68	Domestic	C50-75SM550-A	\$182.00	BDK-312	3/8" - 24	B5002	B5002	B	
	1.75	5.50	0.68	Parlec	C50-75SM550-P	\$177.80	75KY	3/8" - 24	-	028-192	B	
	0.750	1.94	1.50	-	Collis	C50-75SM150-C	\$111.79	64751	3/8" - 24	-	64831	C
		1.94	3.50	-	Collis	C50-75SM350-C	\$130.41	64751	3/8" - 24	-	64831	C
		1.94	5.50	-	Collis	C50-75SM550-C	\$164.01	64751	3/8" - 24	-	64831	C
	0.750	2.00	1.75	0.67	Lyndex	C50-75SM175-L	\$149.00	5/16"	3/8" - 24	-	A3/8-24	B
		2.00	4.00	0.67	Lyndex	C50-75SM400-L	\$179.00	5/16"	3/8" - 24	-	A3/8-24	B
		2.00	6.00	0.67	Lyndex	C50-75SM600-L	\$206.00	5/16"	3/8" - 24	-	A3/8-24	B
		2.00	8.00	0.67	Lyndex	C50-75SM800-L	\$246.00	5/16"	3/8" - 24	-	A3/8-24	B
2.75		1.50	0.68	Domestic	C50-75SM150-A	\$130.90	BDK-312	3/8" - 24	B5002	B5002	B	
2.75		1.50	0.68	Domestic	C50-10SM200-A	\$107.80	BDK-375	1/2" - 20	B5003	B5003	B	
1" 1.000"	2.19	4.00	0.68	Domestic	C50-10SM400-A	\$160.65	BDK-375	1/2" - 20	B5003	B5003	B	
	2.19	6.00	0.68	Domestic	C50-10SM600-A	\$182.00	BDK-375	1/2" - 20	B5003	B5003	B	
	2.25	2.00	0.68	Parlec	C50-10SM200-P	\$104.30	10KY	1/2" - 20	10LS	028-188	B	
	2.25	4.00	0.68	Parlec	C50-10SM400-P	\$128.80	10KY	1/2" - 20	10LS	028-188	B	
	2.25	6.00	0.68	Parlec	C50-10SM600-P	\$147.00	10KY	1/2" - 20	10LS	028-188	B	
	2.75	1.75	0.69	Lyndex	C50-10SM175-L	\$149.00	3/8"	1/2" - 20	-	A1/2-20	B	
	2.75	2.00	-	Kingston	C50-10SM200-K	\$102.43	-	-	-	-	D	
	2.75	2.00	-	Collis	C50-10SM200-C	\$111.79	64752	1/2" - 20	-	64832	C	
	2.75	4.00	-	Kingston	C50-10SM400-K	\$112.45	-	-	-	-	D	
	2.75	4.00	-	Collis	C50-10SM400-C	\$135.66	64752	1/2" - 20	-	64832	C	
	2.75	4.00	0.69	Lyndex	C50-10SM400-L	\$179.00	3/8"	1/2" - 20	-	A1/2-20	B	
	2.75	6.00	-	Kingston	C50-10SM600-K	\$130.50	-	-	-	-	D	
	2.75	6.00	-	Collis	C50-10SM600-C	\$164.01	64752	1/2" - 20	-	64832	C	
	2.75	6.00	0.69	Lyndex	C50-10SM600-L	\$206.00	3/8"	1/2" - 20	-	A1/2-20	B	
	2.75	8.00	0.69	Lyndex	C50-10SM800-L	\$246.00	3/8"	1/2" - 20	-	A1/2-20	B	
1-1/4" 1.250	2.75	1.50	-	Collis	C50-12SM150-C	\$111.79	64753	5/8" - 18	-	64833	C	
	2.75	1.50	0.68	Domestic	C50-12SM150-A	\$130.90	BDK-500	5/8" - 18	B5004	B5004	B	
	2.75	1.50	0.68	Parlec	C50-12SM150-P	\$115.50	12KY	5/8" - 18	12LS	028-193	B	
	2.75	3.50	-	Collis	C50-12SM350-C	\$134.19	64753	5/8" - 18	-	64833	C	
	2.75	3.50	0.68	Parlec	C50-12SM350-P	\$133.70	12KY	5/8" - 18	12LS	028-193	B	
	2.75	5.50	-	Collis	C50-12SM550-C	\$164.01	64753	5/8" - 18	-	64833	C	
	2.75	5.50	0.68	Parlec	C50-12SM550-P	\$175.00	12KY	5/8" - 18	12LS	028-193	B	
	2.88	1.50	-	Kingston	C50-12SM150-K	\$102.43	-	-	-	-	D	
	2.88	1.75	0.69	Lyndex	C50-12SM175-L	\$149.00	1/2"	5/8" - 18	-	A5/8-18	B	
	2.88	3.50	-	Kingston	C50-12SM350-K	\$112.45	-	-	-	-	D	
	2.88	3.50	0.68	Domestic	C50-12SM350-A	\$160.65	BDK-500	5/8" - 18	B5004	B5004	B	
	2.88	4.00	0.69	Lyndex	C50-12SM400-L	\$189.00	1/2"	5/8" - 18	-	A5/8-18	B	
	2.88	5.50	-	Kingston	C50-12SM550-K	\$130.50	-	-	-	-	D	
	2.88	5.50	0.68	Domestic	C50-12SM550-A	\$221.00	BDK-500	5/8" - 18	B5004	B5004	B	
	2.88	6.00	0.69	Lyndex	C50-12SM600-L	\$217.00	1/2"	5/8" - 18	-	A5/8-18	B	
2.88	8.00	0.69	Lyndex	C50-12SM800-L	\$260.00	1/2"	5/8" - 18	-	A5/8-18	B		

Call Us Today For All Of Your Machine Tool Needs!

CAT-50 V-FLANGE SHELL MILL HOLDERS

SHELL MILL HOLDERS

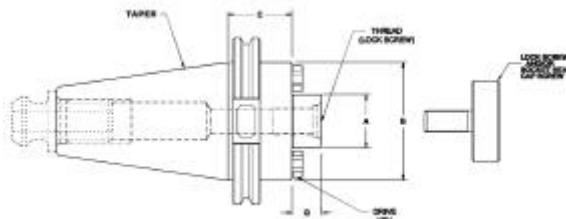

A Pilot Dia	B Dia.	C Proj.	G	Brand	Part Number	Price Each	Drive Key	Screw Thread	Lock Screw	Arbor Screw	Code	
1-1/2"	3.38	2.75	-	Kingston	C50-15SM275-K	\$100.15	-	-	-	-	D	
	3.75	2.40	0.94	Parlec	C50-15SM240-P	\$109.20	15KY	3/4" - 16	15LS	15LS	B	
	3.75	6.00	0.94	Parlec	C50-15SM600-P	\$172.90	15KY	3/4" - 16	15LS	15LS	B	
	3.80	2.00	0.93	Lyndex	C50-15SM200-L	\$165.00	5/8"	3/4" - 16	-	A3/4-16	B	
	3.80	4.00	0.93	Lyndex	C50-15SM400-L	\$199.00	5/8"	3/4" - 16	-	A3/4-16	B	
	3.80	6.00	0.93	Lyndex	C50-15SM600-L	\$236.00	5/8"	3/4" - 16	-	A3/4-16	B	
	1.500	3.81	2.40	0.93	Domestic	C50-15SM240-A	\$119.00	BDK-625	3/4" - 16	B5005	B5005	B
		3.81	4.00	-	Kingston	C50-15SM400-K	\$117.25	-	-	-	-	D
		3.81	4.00	0.93	Domestic	C50-15SM400-A	\$180.20	BDK-625	3/4" - 16	B5005	B5005	B
		3.81	6.00	-	Kingston	C50-15SM600-K	\$145.37	-	-	-	-	D
		3.81	6.00	0.93	Domestic	C50-15SM600-A	\$238.85	BDK-625	3/4" - 16	B5005	B5005	B
		3.94	2.40	-	Collis	C50-15SM240-C	\$119.28	64754	3/4" - 16	-	64834	C
		3.94	4.00	-	Collis	C50-15SM400-C	\$137.90	64754	3/4" - 16	-	64834	C
		3.94	6.00	-	Collis	C50-15SM600-C	\$172.20	64754	3/4" - 16	-	64834	C
	2"	4.38	2.00	0.93	Lyndex	C50-20SM200-L	\$195.00	3/4"	1" - 14	-	A1-14	B
4.38		4.00	0.93	Lyndex	C50-20SM400-L	\$225.00	3/4"	1" - 14	-	A1-14	B	
4.38		6.00	0.93	Lyndex	C50-20SM600-L	\$257.00	3/4"	1" - 14	-	A1-14	B	
4.44		2.40	-	Collis	C50-20SM240-C	\$141.61	64755	1" - 14	-	64835	C	
4.44		4.00	-	Collis	C50-20SM400-C	\$164.01	64755	1" - 14	-	64835	C	
4.44		6.00	-	Collis	C50-20SM600-C	\$196.77	64755	1" - 14	-	64835	C	
2.000		4.88	2.40	0.94	Parlec	C50-20SM240-P	\$137.90	20KY	1" - 14	20LS	20LS	B
		4.88	2.75	-	Kingston	C50-20SM275-K	\$119.95	-	-	-	-	D
		4.88	4.00	0.94	Parlec	C50-20SM400-P	\$156.80	20KY	1" - 14	20LS	20LS	B
		4.88	4.00	-	Kingston	C50-20SM400-K	\$140.40	-	-	-	-	D
		4.88	6.00	-	Kingston	C50-20SM600-K	\$165.25	-	-	-	-	D
		4.88	6.00	0.93	Domestic	C50-20SM600-A	\$294.10	BDK-750	1" - 14	B5006	B5006	B
		4.88	6.00	0.94	Parlec	C50-20SM600-P	\$229.60	20KY	1" - 14	20LS	20LS	B
	5.06	2.95	0.86	Lyndex	C50-20FM295-L	\$238.00	3/4"	Face Mill	-	-	B	
2-1/2"	4.88	2.40	-	Kingston	C50-25SM240-K	\$160.45	-	-	-	-	D	
	4.88	2.40	-	Collis	C50-25SM240-C	\$192.29	64756	1" - 14	-	64836	C	
	4.88	2.40	1.12	Parlec	C50-25SM240-P	\$179.90	25KY	1" - 14	25LS	25LS	B	
	4.88	4.00	-	Kingston	C50-25SM400-K	\$190.96	-	-	-	-	D	
	4.88	4.00	-	Collis	C50-25SM400-C	\$225.12	64756	1" - 14	-	64836	C	
	4.88	4.00	1.12	Parlec	C50-25SM400-P	\$224.00	25KY	1" - 14	25LS	25LS	B	
	4.88	6.00	1.12	Parlec	C50-25SM600-P	\$253.40	25KY	1" - 14	25LS	25LS	B	
	5.00	2.95	1.18	Lyndex	C50-25FM295-L	\$284.00	1.00"	Face Mill	-	-	B	

90° MILLING CUTTERS

- High Positive Design
- Free Cutting
- Excellent Chip Control
- Made in USA!



E

Description	Dia.	Shank Dia.	No. Of Teeth	Part Number	Price Each	Extra Screw	Torx Wrench
SHELL MILLS	2.00	0.75	4	TB-2000	\$173.00	SC-01	TX-20S \$5.00
	2.00	0.75	5	TB-2005	\$235.00	\$ 1.00	
	3.00	1.00	6	TB-3000	\$216.00	SC-02	
	4.00	1.25	7	TB-4000	\$292.00	\$ 1.00	

MILLING INSERTS

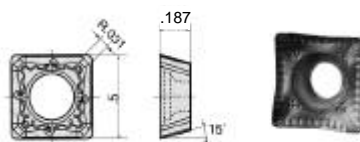

G

Material	Reference Number	Polished	Coated
For Aluminum, Copper, Brass	SDGT1204PDFR-AJ-TH10	US-820 \$ 9.80	-
For Mild Steel, Stainless Steel, Super Alloys	SDMT1204P DPR-ML-AH120	-	US-821 \$6.95
For Alloy Steels, Die Steels, Cast Iron	SDMT1204PDSR-MJ-AH120	-	US-822 \$6.95

Call Us Or Visit Our Website For Our Complete Selection!

BT 40 TAPER SHELL MILL HOLDERS

SHELL MILL HOLDERS

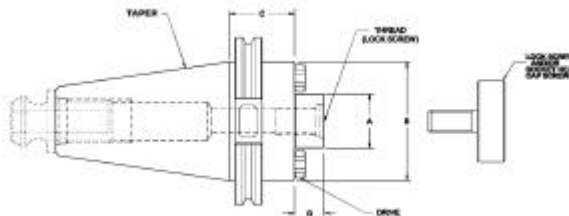

**BT-50 Toolholders
Also Available!**



A Pilot Dia	B Dia.	C Proj.	G	Brand	Part Number	Price Each	Drive Key	Screw Thread	Lock Screw	Arbor Screw	Code
1/2" 0.500	1.38	1.75	0.57	Lyndex	B40-50SM175-L	\$145.00	1/4"	1/4" - 28	-	A1/4-28	B
	1.75	1.38	-	Kingston	B40-50SM138-K	\$81.40	-	-	-	-	D
	1.75	3.50	-	Kingston	B40-50SM350-K	\$90.69	-	-	-	-	D
3/4" 0.750	-	1.75	-	Kingston	B40-75SM175-K	\$48.17	-	-	-	-	D
	1.73	1.75	-	Collis	B40-75SM175-C	\$103.04	64751	3/8" - 24	-	64831	C
	1.75	1.38	0.68	Domestic	B40-75SM137-A	\$114.75	BDK-312	3/8" - 24	B5002	B5002	B
	1.75	2.00	0.68	Parlec	B40-75SM200-P	\$93.80	75KY	3/8" - 24	-	028-192	B
	1.75	3.50	-	Kingston	B40-75SM350-K	\$90.69	-	-	-	-	D
	1.75	4.00	0.68	Parlec	B40-75SM400-P	\$124.60	75KY	3/8" - 24	-	028-192	B
	1.75	6.00	-	Kingston	B40-75SM600-K	\$110.69	-	-	-	-	D
	2.00	1.75	0.67	Lyndex	B40-75SM175-L	\$135.00	5/16"	3/8" - 24	-	A3/8-24	B
1" 1.000	-	2.25	-	Kingston	B40-10SM225-K	\$81.60	-	-	-	-	D
	2.19	1.00	-	Kingston	B40-10SM100-K	\$81.60	-	-	-	-	D
	2.19	1.75	-	Collis	B40-10SM175-C	\$103.04	64752	1/2" - 20	-	64832	C
	2.19	2.06	0.68	Domestic	B40-10SM206-A	\$114.75	BDK-375	1/2" - 20	B5003	B5003	B
	2.19	4.00	-	Kingston	B40-10SM400-K	\$94.69	-	-	-	-	D
	2.19	6.00	-	Kingston	B40-10SM600-K	\$130.50	-	-	-	-	D
	2.25	2.00	0.68	Parlec	B40-10SM200-P	\$93.80	10KY	1/2" - 20	10LS	028-188	B
	2.25	4.00	0.68	Parlec	B40-10SM400-P	\$119.00	10KY	1/2" - 20	10LS	028-188	B
1-1/4" 1.250	2.38	1.75	0.67	Lyndex	B40-10SM175-L	\$135.00	3/8"	1/2" - 20	-	A1/2-20	B
	2.75	2.00	-	Collis	B40-12SM200-C	\$103.04	64753	5/8" - 18	-	64833	C
	2.75	2.25	0.68	Parlec	B40-12SM225-P	\$102.20	12KY	5/8" - 18	12LS	028-193	B
	2.88	1.62	-	Kingston	B40-12SM162-K	\$81.60	-	-	-	-	D
	2.88	2.00	0.67	Lyndex	B40-12SM200-L	\$145.00	1/2"	5/8" - 18	-	A5/8-18	B
	2.88	2.12	-	Kingston	B40-12SM212-K	\$81.60	-	-	-	-	D
	2.88	2.12	0.68	Domestic	B40-12SM212-A	\$114.75	BDK-500	5/8" - 18	B5004	B5004	B
	2.88	2.50	-	Kingston	B40-12SM250-K	\$81.60	-	-	-	-	D
1-1/2" 1.500	2.88	4.00	-	Kingston	B40-12SM400-K	\$94.69	-	-	-	-	D
	3.38	1.62	-	Kingston	B40-15SM162-K	\$81.60	-	-	-	-	D
	3.38	2.50	-	Kingston	B40-15SM250-K	\$85.99	-	-	-	-	D
	3.38	4.00	-	Kingston	B40-15SM400-K	\$97.69	-	-	-	-	D
	3.62	2.12	-	Collis	B40-15SM212-C	\$121.76	64754	3/4" - 16	-	64834	C
	3.75	2.25	0.94	Parlec	B40-15SM225-P	\$108.50	15KY	3/4" - 16	15LS	15LS	B
	3.80	2.00	0.92	Lyndex	B40-15SM200-L	\$160.00	5/8"	3/4" - 16	-	A3/4-16	B
	3.81	2.40	0.94	Domestic	B40-15SM240-A	\$120.70	BDK-625	3/4" - 16	B5005	B5005	B

90° MILLING CUTTERS



- High Positive Design
- Free Cutting
- Excellent Chip Control
- Made in USA!



E

Description	Dia.	Shank Dia.	No. Of Teeth	Part Number	Price Each	Extra Screw	Torx Wrench
SHELL MILLS	2.00	0.75	4	TB-2000	\$173.00	SC-01	TX-20S \$5.00
	2.00	0.75	5	TB-2005	\$235.00	\$ 1.00	
	3.00	1.00	6	TB-3000	\$216.00	SC-02	
	4.00	1.25	7	TB-4000	\$292.00	\$ 1.00	

MILLING INSERTS

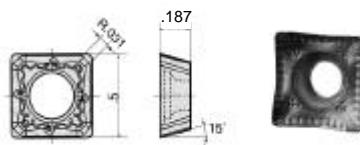

G

Material	Reference Number	Polished	Coated
For Aluminum, Copper, Brass	SDGT1204PDFR-AJ-TH10	US-820 \$ 9.80	-
For Mild Steel, Stainless Steel, Super Alloys	SDMT1204PDPR-ML-AH120	-	US-821 \$6.95
For Alloy Steels, Die Steels, Cast Iron	SDMT1204PDSR-MJ-AH120	-	US-822 \$6.95

Call Us Today For All Of Your Machine Tool Needs!