

COOLANT THRU INDEXABLE DRILLS



TRIDEX™ INDEXABLE DRILLS KOMET™ “Kub-It HD” COMPATIBLE Coolant Thru Indexable Drills



THE PRICE/PERFORMANCE WINNER IN THE INDUSTRY!

SBM's TRIDEX Indexable Drills present the **BEST VALUE** by combining excellent quality with possibly the lowest prices in the market for drills made in USA. The following pages are dedicated to introducing you to SBM Indexable drills and to provide you with helpful suggestions to increase your drilling operations productivity.

PREMIUM DRILLS NOW AVAILABLE!

Our popular SBM TRIDEX Indexable Drills are now available in a premium style that offer longer life and reduced wear due to better tool steel (H-13) and increased hardness to Rc 46/50. Our new premium drill life is at least 50% longer than that of our standard drills. As supplies of our standard drills decrease, our new premium drills will replace them in order to give you a better drill at a great value!

A GREAT INDEXABLE DRILL JUST GOT BETTER !

- **Beefier Design** - for greater tool strength and rigidity
- **Improved Flute Design** - for better chip removal
- Now **manufactured from H13 Steel** - for greater tool strength and reduced wear.

IMPROVED INSERT DESIGN AND GRADES

- **Ground Edges** - better edge prep
- **CVD Coating** - latest coating technology - (increasing insert life compared to older PVD coatings)
- **New Insert Grades** SBP35 (Coated C5) designed for drilling steels and 400 Series Stainless; Grade SZP40 (Coated C2) drills great in 300 Series Stainless and High temp alloys – both new grades have better wear resistance and show greater edge strength than previous grades.
- **KOMET KUB Trigon Inserts** are offered as well in our catalog. These inserts work great with all our drills.
- **TRIDEX** brand Drill Inserts are 100% compatible with KOMET KUB drills (for applicable sizes).



SBM TRIDEX Indexable Drills using trigon inserts are designed to provide greater cutting speeds, reduced tooling / operating costs and increased tooling versatility as compared with standard twist drills.

A unique feature of SBM coolant through Indexable Drills – not found on any other drill on the market – is the 3 methods of coolant entry into the drill. a) Rear Entry – coolant supply through the back of the shank. b) Side Entry – coolant supply through the side of the tool. c) Through the Holder – for Mori-Seiki and other machines – coolant supply through the slot on the shank. This unique feature of SBM Indexable Drills allows the use of the same drill on different machines .

ALL SBM TRIDEX™ COOLANT THROUGH INDEXABLE DRILLS ARE :

- **100% Compatible** with inserts for KOMET KUB-IT drills (see table for compatibility and usage) & Kennametal DFT-__ 84° Trigon drill inserts.
- **Black oxide surface** to prevent against rust and corrosion.
- **Length to diameter ratios are kept optimal** tool overhang is minimized and tool rigidity, accuracy and deflection are minimized even in deeper holes.
- **Spiral flutes to improve chip evacuation** while keeping tool strength intact.
- **Insert pockets are precisely positioned** to keep cutting forces low and evenly distributed thus -lower axial pressures are realized. The net result of this is minimal tool deflection which in turn produces straighter holes regardless of whether the surface being drilled is concave, convex or is a low angle surface.
- **Trigon Inserts** - our unique 84° Nose angle Trigon inserts provide the strength of a square insert with the versatility of a triangular insert. The 8° positive relief angle provides for easier cutting by using positive cutting action. The 156° angle between cutting edges - provides twofold benefits - eliminates the need for spotfacing or pre-centering before drilling and helps tool stabilization during drilling. Can be indexed 3 times.
- **100% Guaranteed** against defects and backed by our Industry Famous guarantee.
- **SBM TRIDEX Premium Drills are Manufactured from H13 steel** for superior tool toughness and strength - premium drills will replace standard drills, as standard drills are phased out.

SBM Coolant Through Indexable drills are designed for drilling holes – 0.750” to 3.25” and are available in 1”, 2”, 3”, 4”, 5” & 6” (for drill dia >=1.00”) drill depth sizes.

When drilling deeper than 1X drill diameter, coolant through the drill is essential - flood coolant cannot perform satisfactorily at depths beyond 1X drill diameter.

**KOMET, Kub-It and Kennametal are trademarks of their respective companies.*

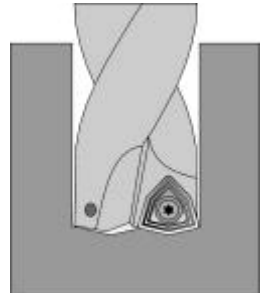

Call Us Today For All Of Your Machine Tool Needs!

TRIDEX INDEXABLE DRILLS

Drilling Tips



Indexable drills are designed strictly for roughing – and as such are not meant to be used for finishing. Tolerances of $\pm .005$ " and finishes of 250 rms are normal.

FIXTURE RIGIDITY is extremely important when using indexable drills. Workpieces should be of adequate strength – flimsy workpieces will cause drills to be rendered almost ineffective due to high horsepower requirements.

RUNOUT must be checked with the drill in the toolholder. Position the drill such that the inboard station is positioned below center radially. This allows the inboard insert to cut past the center. Using a dial indicator check the drill for location – if the location varies more than .002" at the holder and/or .006" at the cutting edge of the drill then the drill and holder must be repositioned or the TIR of the holder must be checked/adjusted.

ADEQUATE COOLANT is essential when using indexable drills. Maximum heat is produced in a small area at the bottom of the hole being drilled. Coolant needs to be used to remove heat and chips from the bottom of the hole, along the flutes of the drill and out of the hole. In general 10-20gpm at 45psi of coolant is required during drilling. When drilling deeper than 1X drill diameter, coolant through the drill is essential - flood coolant cannot perform satisfactorily at depths beyond 1X drill diameter.

PROPER CHIP CONTROL is absolutely necessary to remove chips, this improves hole tolerance and finish and also improves tool life. Adjust speed and feed to produce "figure 9" chips for optimal chip removal – longer chips will lead to chip buildup in the drill flutes and chip recutting and eventual drill failure.

- Increase speed – within limits - if chips are too short. If chips are still unsatisfactory – reduce feed.
- Decrease speed or increase feed if chips are too long.

OFFSETTING DRILLS with 2.5:1 length to diameter ratios, in a positive direction, has proven to be beneficial when using indexable drills on machines with inadequate coolant supply. Offsetting will reduce chatter and improve surface finish. Offsetting is also useful when drilling a slightly oversized hole. This allows for drilling a larger range of hole diameters with a minimum of drill diameter.

HORSEPOWER A machine with at least seven horsepower is required to run an indexable drill. Just because a machine has enough horsepower to run a twist drill or a spade drill does not mean it can run an indexable drill.

SBM Indexable drills are not designed to be used with stacked materials or laminates – severe tool damage and loss will occur if used with such materials.

On some CNC machines, the rapid rate of tool positioning does not allow enough time for coolant flow to begin prior to drill contact with the workpiece. If the drill begins cutting without coolant, even for a second or two, insert life can be greatly reduced. Adding a short dwell in the program, to assure coolant flow BEFORE workpiece contact, will considerably increase insert life and drill performance. The slug produced by drilling through a workpiece can sometimes become jammed between the drill and workholding device. To minimize the likelihood of this happening, provide ample clearance in this area.

DRILL SELECTION:

Selecting your drill and inserts with our tables is easy :

- Step 1** - Select the **drill diameter** you need from col. "D"
(labels in top row of table)
- Step 2** - Select the **shank size** you require for your drill station from col. "S" (labels in top row of table).
- Step 3** - Select the **drilling depth** you require to drill from the **appropriate block** (labels in top row of table)
- Step 4** - Select a **Standard drill or a Premium drill** (see note above for explanation); match the last 3 digits of the Drill Part Number to the **appropriate insert** (middle 3 or 4 digits of Insert Part Number) and grade (based on your application).

SPECIAL SHIPPING RATES ON INDEXABLE DRILLS & INSERTS!

Special Shipping Rates On Inserts!
(Up to 1 pound/envelope)
FedEx Priority™ (Next day by 10:30am) **\$12.00**
FedEx Standard Overnight (by 4:30pm) **\$10.00**
FedEx 2nd Day (By 4:30pm) **\$8.00**

Special Shipping Rates on Indexable Drills!
(Up to 5 pounds/package)
FedEx 2nd Day (By 4:30pm) **\$12.00**



DRILL SAFETY

CAUTION !!!

When the drill first comes into contact with the workpiece a slug of velocity and can cause considerable injury should it hit the operator. ALWAYS KEEP SAFETY GUARDS in place to protect the operator from injury, during all stages of drilling operations.

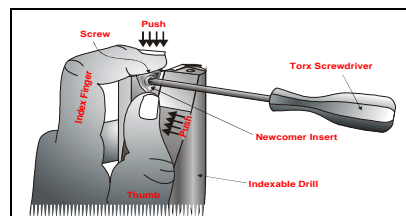

To help insure the proper placement of the insert you should hold the insert in place with your thumb and index finger while tightening the torx screw with your other hand.

Call Us Or Visit Our Website For Our Complete Selection!

COOLANT THRU INDEXABLE DRILLS

TRIDEX™ INDEXABLE DRILLS
KOMET™ “Kub-It HD” COMPATIBLE
 Coolant Thru Indexable Drills



- FEATURES:**
- **Premium Drills:** Manufactured from H-13 steel (hardened to Rc 46/50) for greater tool strength, reduced wear and longer tool life
 - **Standard Drills:** Manufactured from tool steel- a quality drill at a great price!
 - Compatible with inserts for Komet Kub-It™ drills and Kennametal DFT- 84° trigon inserts
 - Spiral flutes to improve chip evacuation
 - Insert pockets are precisely positioned to keep cutting forces low and evenly distributed
 - 100% Guaranteed against defects
 - Black oxide finish for long life
 - Made in the USA!



Drill Type:
S=Standard Drill
P=Premium Drill

Shank Dia: 1.000" to 1.500"
Drill Dia: 0.750" to 3.250"
Drill Depths: 1" to 6"

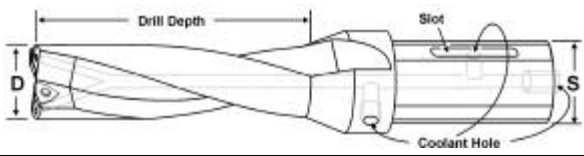

D		S		Drill Depth 1.00"				Drill Depth 2.00"				Drill Depth 3.00"				Drill Depth 4.00" and Over			
Drill Dia.	Shank Size	Part Number	Drill Type	Price Each	Part Number	Drill Type	Price Each	Part Number	Drill Type	Price Each	Flute Len.	Part Number	Drill Type	Price Each					

0.750 - 0.937 Drill Diameter- 0.236 Insert I.C.															
3/4	0.750	1.00	DK0750-1010-236	P	\$201.25	DK0750-2010-236	P	\$230.00	DK0750-3010-236	P	\$253.00	4"	DK0750-4010-236	P	\$293.25
	0.750	1.25	DK0750-1012-236	P	\$201.25	DK0750-2012-236	P	\$230.00	DK0750-3012-236	P	\$253.00		DK0750-4012-236	P	\$293.25
13/16	0.812	1.00	DK0812-1010-236	P	\$201.25	DK0812-2010-236	P	\$230.00	DK0812-3010-236	P	\$253.00	4"	DK0812-4010-236	P	\$293.25
	0.812	1.25	DK0812-1012-236	P	\$201.25	DK0812-2012-236	P	\$230.00	DK0812-3012-236	P	\$253.00		DK0812-4012-236	P	\$293.25
7/8	0.875	1.00	DK0875-1010-236	P	\$201.25	DK0875-2010-236	P	\$230.00	DK0875-3010-236	P	\$253.00	4"	DK0875-4010-236	P	\$293.25
	0.875	1.25	DK0875-1012-236	P	\$201.25	DK0875-2012-236	P	\$230.00	DK0875-3012-236	P	\$253.00		DK0875-4012-236	P	\$293.25
15/16	0.937	1.00	DK0937-1010-236	P	\$201.25	DK0937-2010-236	P	\$230.00	DK0937-3010-236	P	\$253.00	4"	DK0937-4010-236	P	\$293.25
	0.937	1.25	DK0937-1012-236	P	\$201.25	DK0937-2012-236	P	\$230.00	DK0937-3012-236	P	\$253.00		DK0937-4012-236	P	\$293.25

Special Shipping Rates On Indexable Drills & Inserts!
 (Up to 5 pounds/package)
FedEx 2nd Day
 (By 4:30pm) **\$12.00**

1.000 - 1.125 Drill Diameter- 0.315 Insert I.C.															
1"	1.000	1.00	DK1000-1010-315	P	\$207.00	DK1000-2010-315	P	\$235.75	DK1000-3010-315	P	\$264.50	4"	DK1000-4010-315	P	\$293.25
	1.000	1.25	DK1000-1012-315	S	\$169.05	DK1000-2012-315	P	\$235.75	DK1000-3012-315	P	\$264.50		DK1000-4012-315	P	\$293.25
1-1/32	1.031	1.00	DK1031-1010-315	S	\$169.05	DK1031-2010-315	S	\$193.20	DK1031-3010-315	S	\$217.35	4"	DK1031-4010-315	S	\$241.50
	1.031	1.25	DK1031-1012-315	S	\$169.05	DK1031-2012-315	S	\$193.20	DK1031-3012-315	P	\$264.50		DK1031-4012-315	S	\$241.50
1-1/16	1.062	1.00	DK1062-1010-315	P	\$207.00	DK1062-2010-315	P	\$235.75	DK1062-3010-315	S	\$217.35	4"	DK1062-4010-315	P	\$293.25
	1.062	1.25	DK1062-1012-315	S	\$169.05	DK1062-2012-315	P	\$235.75	DK1062-3012-315	P	\$264.50		DK1062-4012-315	P	\$293.25
1-1/8	1.125	1.00	DK1125-1010-315	S	\$169.05	DK1125-2010-315	P	\$235.75	DK1125-3010-315	P	\$264.50	4"	DK1125-4010-315	S	\$241.50
	1.125	1.25	DK1125-1012-315	S	\$169.05	DK1125-2012-315	P	\$235.75	DK1125-3012-315	P	\$264.50		DK1125-4012-315	S	\$241.50

1.187 - 1.750 Drill Diameter- 0.394 Insert I.C.															
1-3/16	1.187	1.00	DK1187-1010-394	P	\$207.00	DK1187-2010-394	P	\$235.75	DK1187-3010-394	P	\$264.50	4"	DK1187-4010-394	S	\$241.50
	1.187	1.25	DK1187-1012-394	S	\$169.05	DK1187-2012-394	P	\$235.75	DK1187-3012-394	P	\$264.50		DK1187-4012-394	P	\$293.25
1-1/4	1.250	1.00	DK1250-1010-394	P	\$212.75	DK1250-2010-394	P	\$241.50	DK1250-3010-394	P	\$276.00	4"	DK1250-4010-394	P	\$299.00
	1.250	1.25	DK1250-1012-394	S	\$175.09	DK1250-2012-394	P	\$241.50	DK1250-3012-394	P	\$276.00		DK1250-4012-394	P	\$299.00
1-5/16	1.312	1.00	DK1312-1010-394	S	\$175.09	DK1312-2010-394	P	\$241.50	DK1312-3010-394	S	\$223.39	4"	DK1312-4010-394	S	\$247.54
	1.312	1.25	DK1312-1012-394	S	\$175.09	DK1312-2012-394	P	\$241.50	DK1312-3012-394	P	\$276.00		DK1312-4012-394	P	\$299.00
1-3/8	1.375	1.00	DK1375-1010-394	S	\$175.09	DK1375-2010-394	S	\$199.24	DK1375-3010-394	S	\$223.39	4"	DK1375-4010-394	S	\$247.54
	1.375	1.25	DK1375-1012-394	S	\$175.09	DK1375-2012-394	P	\$241.50	DK1375-3012-394	S	\$223.39		DK1375-4012-394	P	\$299.00
1-7/16	1.437	1.00	DK1437-1010-394	S	\$175.09	DK1437-2010-394	S	\$199.24	DK1437-3010-394	S	\$223.39	4"	DK1437-4010-394	S	\$247.54
	1.437	1.25	DK1437-1012-394	S	\$175.09	DK1437-2012-394	P	\$241.50	DK1437-3012-394	P	\$276.00		DK1437-4012-394	P	\$299.00
1-1/2	1.500	1.00	DK1500-1010-394	S	\$181.13	DK1500-2010-394	P	\$247.25	DK1500-3010-394	P	\$281.75	4"	DK1500-4010-394	P	\$304.75
	1.500	1.25	DK1500-1012-394	S	\$181.13	DK1500-2012-394	P	\$247.25	DK1500-3012-394	P	\$281.75		DK1500-4012-394	P	\$304.75
1-9/16	1.562	1.00	DK1562-1010-394	S	\$181.13	DK1562-2010-394	P	\$247.25	DK1562-3010-394	S	\$229.43	4"	DK1562-4010-394	S	\$253.58
	1.562	1.25	DK1562-1012-394	S	\$181.13	DK1562-2012-394	S	\$205.28	DK1562-3012-394	S	\$229.43		DK1562-4012-394	P	\$304.75
1-5/8	1.625	1.00	DK1625-1010-394	S	\$181.13	DK1625-2010-394	S	\$205.28	DK1625-3010-394	S	\$229.43	4"	DK1625-4010-394	S	\$253.58
	1.625	1.25	DK1625-1012-394	S	\$181.13	DK1625-2012-394	P	\$253.00	DK1625-3012-394	S	\$229.43		DK1625-4012-394	P	\$304.75
1-11/16	1.687	1.00	DK1687-1010-394	S	\$181.13	DK1687-2010-394	S	\$205.28	DK1687-3010-394	S	\$229.43	4"	DK1687-4010-394	S	\$253.58
	1.687	1.25	DK1687-1012-394	S	\$181.13	DK1687-2012-394	P	\$253.00	DK1687-3012-394	S	\$229.43		DK1687-4012-394	P	\$304.75
1-3/4"	1.750	1.00	DK1750-1010-394	S	\$187.16	DK1750-2010-394	S	\$211.31	DK1750-3010-394	S	\$235.46	4"	DK1750-4010-394	S	\$259.61
	1.750	1.25	DK1750-1012-394	S	\$187.16	DK1750-2012-394	P	\$253.00	DK1750-3012-394	P	\$287.50		DK1750-4012-394	P	\$310.50
	1.750	1.25	-	-	-	-	-	-	-	-	5"	DK1750-5012-394	P	\$333.50	

1.812 - 2.125 Drill Diameter- 0.472 Insert I.C.															
1-13/16	1.812	1.25	DK1812-1012-472	P	\$230.00	DK1812-2012-472	P	\$253.00	DK1812-3012-472	P	\$287.50	4"	DK1812-4012-472	S	\$259.61
	1-7/8	1.875	1.25	DK1875-1012-472	P	\$230.00	DK1875-2012-472	P	\$253.00	DK1875-3012-472	P		\$287.50	DK1875-4012-472	S
1-15/16	1.937	1.25	DK1937-1012-472	S	\$187.16	DK1937-2012-472	P	\$253.00	DK1937-3012-472	S	\$235.46	4"	DK1937-4012-472	P	\$310.50
	2"	2.000	1.25	DK2000-1012-472	S	\$241.50	DK2000-2012-472	P	\$333.50	DK2000-3012-472	P		\$368.00	DK2000-4012-472	P
2"	2.000	1.25	-	-	-	-	-	-	-	-	5"	DK2000-5012-472	P	\$425.50	
	2.000	1.25	-	-	-	-	-	-	-	-	6"	DK2000-6012-472	P	\$448.50	
2-1/8	2.125	1.50	DK2125-1015-472	P	\$293.25	DK2125-2015-472	P	\$333.50	DK2125-3015-472	P	\$368.00	4"	DK2125-4015-472	P	\$402.50

*KOMET, Kub-It and Kennametal are trademarks of their respective companies.

Larger Diameter Drills Continued Page 293

Call Us Today For All Of Your Machine Tool Needs!

COOLANT THRU INDEXABLE DRILLS

E

INDEXABLE DRILLS (continued)

Coolant Thru

Drill Type:
S=Standard Drill
P=Premium Drill

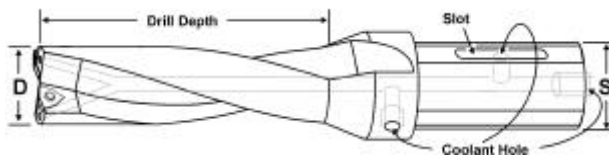

D Drill Dia.	S Shank Size	Drill Depth 1.00"			Drill Depth 2.00"			Drill Depth 3.00"			Drill Depth 4.00" and Over				
		Part Number	Drill Type	Price Each	Part Number	Drill Type	Price Each	Part Number	Drill Type	Price Each	Flute Len.	Part Number	Drill Type	Price Each	
2.250 - 2.500 Drill Diameter- 0.590 Insert I.C.															
2-1/4"	2.250	1.50	DK2250-1015-590	P	\$327.75	DK2250-2015-590	P	\$356.50	DK2250-2015-590	P	\$396.75	4"	DK2250-4015-590	P	\$431.25
	2.250	1.50	-	-	-	-	-	-	-	-	-	5"	DK2250-5015-590	P	\$454.25
	2.250	1.50	-	-	-	-	-	-	-	-	-	6"	DK2250-6015-590	P	\$477.25
2-3/8"	2.375	1.50	DK2375-1015-590	P	\$327.75	DK2375-2015-590	P	\$356.50	DK2375-2015-590	P	\$396.75	4"	DK2375-4015-590	P	\$431.25
	2.500	1.50	DK2500-1015-590	P	\$350.75	DK2500-2015-590	P	\$379.50	DK2500-2015-590	P	\$425.50	4"	DK2500-4015-590	P	\$460.00
2-1/2"	2.500	1.50	-	-	-	-	-	-	-	-	-	5"	DK2500-5015-590	P	\$483.00
	2.500	1.50	-	-	-	-	-	-	-	-	-	6"	DK2500-6015-590	P	\$506.00
	2.500	1.50	-	-	-	-	-	-	-	-	-	-	-	-	

2.750 - 3.250 Drill Diameter- 0.693 Insert I.C.															
2-3/4"	2.750	1.50	DK2750-1015-693	P	\$350.75	DK2750-2015-693	P	\$379.50	DK2750-3015-693	P	\$425.50	4"	DK2750-4015-693	P	\$460.00
	2.750	1.50	-	-	-	-	-	-	-	-	-	5"	DK2750-5015-693	P	\$483.00
	2.750	1.50	-	-	-	-	-	-	-	-	-	6"	DK2750-6015-693	P	\$506.00
3"	3.000	1.50	DK3000-1015-693	P	\$379.50	DK3000-2015-693	P	\$419.75	DK3000-3015-693	P	\$454.25	4"	DK3000-4015-693	S	\$477.25
	3.000	1.50	-	-	-	-	-	-	-	-	-	5"	DK3000-5015-693	P	\$500.25
	3.000	1.50	-	-	-	-	-	-	-	-	-	6"	DK3000-6015-693	P	\$523.25
3-1/4"	3.250	1.50	DK3250-1015-693	P	\$379.50	DK3250-2015-693	P	\$419.75	DK3250-3015-693	P	\$454.25	4"	DK3250-4015-693	P	\$477.25

INDEXABLE DRILL INSERTS

A Major feature of the TRIGON insert is its 84° nose angle which combines the strength of a square with the versatility of a triangular insert.

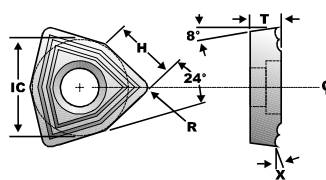
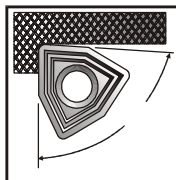

TRIDEX™ PREMIUM TRIGON COATED INDEXABLE DRILL INSERTS

Drill Dia	IC	T	H	X	R	Coated Inserts		Uncoated Inserts		Torx Driver	Screw
						Grade SZP40 Coated C2 Steel, SS, Hi-Temp	Grade SBP35 Coated C5 Steel, SS	-	-		
0.562 - 0.781	0.197	0.091	0.126	8°	0.016	TRX-197-SZP40-A \$6.80	TRX-197-SBP35-A \$6.80	NOT NECESSARY	NOT NECESSARY	TX-206 \$5.00	SC-29 \$1.25
0.812 - 0.937	0.250	0.125	0.161	8°	0.016	TRX-250-SZP40-A \$6.78	TRX-250-SBP35-A \$6.78	NOT NECESSARY	NOT NECESSARY	TX-206 \$5.00	SC-30 \$1.25
0.750 - 0.937	0.236	0.094	0.157	8°	0.016	-	-	NOT NECESSARY	NOT NECESSARY	-	-
1.000 - 1.125	0.315	0.146	0.209	12°	0.016	TRX-315-SZP40-A \$6.90	TRX-315-SBP35-A \$6.90	NOT NECESSARY	NOT NECESSARY	TX-208 \$5.00	SC-34 \$1.25
1.187 - 1.750	0.394	0.146	0.260	12°	0.016	TRX-394-SZP40-A \$7.71	TRX-394-SBP35-A \$7.71	NOT NECESSARY	NOT NECESSARY	TX-210 \$5.00	SC-35 \$1.25
1.812 - 2.125	0.472	0.185	0.311	12°	0.016	TRX-472-SZP40-A \$9.88	TRX-472-SBP35-A \$9.88	NOT NECESSARY	NOT NECESSARY	TX-215 \$5.00	SC-36 \$1.25
2.250 - 2.500	0.591	0.205	0.390	12°	0.016	TRX-591-SZP40-A \$13.49	TRX-591-SBP35-A \$13.49	NOT NECESSARY	NOT NECESSARY	TX-215 \$5.00	SC-36 \$1.25
2.750 - 3.250	0.693	0.232	0.457	12°	0.031	TRX-693-SZP40-A \$15.68	TRX-693-SBP35-A \$15.68	NOT NECESSARY	NOT NECESSARY	TX-220 \$5.00	SC-37 \$1.25

KOMET KUB TRIGON COATED & UNCOATED INDEXABLE DRILL INSERTS

Genuine KOMET Inserts

KOMET™

Drill Dia	IC	T	H	X	R	Coated Inserts		Uncoated Inserts		Torx Driver	Screw
						Komet Grade BK62 TiCN/Al2O3-CVD Coated C2- Cast Iron	Komet Grade BK84 C5- Steels, Cast Steels, Stainless	Komet Grade K10 C2- Aluminum Cast Iron	Komet Grade P40 C5- Non-Alloy & Die Steels, SS		
0.750 - 0.937	0.236	0.098	0.157	8°	0.016	KOM-0236-BK62 \$10.95	KOM-0236-BK84 \$10.47	KOM-0236-K10 \$7.19	KOM-0236-P40 \$7.19	TX-208 \$5.00	SC-63 \$1.25
1.000 - 1.125	0.315	0.150	0.209	12°	0.016	KOM-0315-BK62 \$7.97	KOM-0315-BK84 \$7.97	KOM-0315-K10 \$5.93	KOM-0315-P40 \$5.93	TX-208 \$5.00	SC-34 \$1.25
1.187 - 1.750	0.394	0.150	0.260	12°	0.016	KOM-0394-BK62 \$9.15	KOM-0394-BK84 \$9.15	KOM-0394-K10 \$7.02	KOM-0394-P40 \$7.02	TX-210 \$5.00	SC-35 \$1.25
1.812 - 2.125	0.472	0.189	0.311	12°	0.016	KOM-0472-BK62 \$10.80	KOM-0472-BK84 \$10.80	KOM-0472-K10 \$8.82	KOM-0472-P40 \$8.82	TX-215 \$5.00	SC-36 \$1.25
2.250 - 2.500	0.591	0.209	0.390	12°	0.016	KOM-0590-BK62 \$15.21	KOM-0590-BK84 \$15.51	KOM-0590-K10 \$12.07	KOM-0590-P40 \$12.07	TX-215 \$5.00	SC-36 \$1.25
2.750 - 3.250	0.693	0.236	0.457	12°	0.031	KOM-0693-BK62 \$19.12	KOM-0693-BK84 \$19.12	KOM-0693-K10 \$16.19	KOM-0693-P40 \$15.86	TX-220 \$5.00	SC-37 \$1.25

Call Us Or Visit Our Website For Our Complete Selection!

INDEXABLE DRILLS INSERTS- Grade Information

TRIDEX™ PREMIUM TRIGON COATED INDEXABLE DRILL INSERTS
SPEED & FEED INFORMATION
 Made In Germany



TRIDEX Insert Grades	
Grade	Application
SZP40	Excellent for general purpose machining of Steels, 300 Series Stainless Steels & Hi-Temp Alloys
SBP35	Ideal grade for general purpose machining of Steels & 400 Series Stainless Steels

SPECIAL SHIPPING RATES ON INDEXABLE DRILLS & INSERTS!
Special Shipping Rates On Inserts!
 (Up to 1 pound/envelope)
 FedEx Priority™ (Next day by 10:30am) **\$12.00**
 FedEx Standard Overnight (by 4:30pm) **\$10.00**
 FedEx 2nd Day (By 4:30pm) **\$8.00**

Special Shipping Rates on Indexable Drills!
 (Up to 5 pounds/package)
 FedEx 2nd Day (By 4:30pm) **\$12.00**



TRIDEX PREMIUM INSERTS			Brinell Hardness-HB	Mach Group	DOC [in] Drill Dia.					SBP 35			SZP 40		
Mat. Group	Workpiece Material				.472-.547	.500-.784	.787-0.980	.984-1.777	>1.778	f [in./rev.]			f [in./rev.]		
P	Unalloyed steel	approx. 0.15% C annealed	125	1	.002	.002	.003	.004	.005	720	660	590	460	430	390
		approx. 0.45% C annealed	190	2	.002	.002	.003	.004	.005	720	660	590	460	430	390
		approx. 0.45% C tempered	250	3	.002	.002	.003	.004	.005	720	660	590	460	430	390
		approx. 0.75% C annealed	270	4	.002	.002	.003	.004	.005	720	660	590	460	430	390
		approx. 0.75% C tempered	300	5	.002	.002	.003	.004	.005	720	660	590	460	430	390
	Low-alloyed steel	annealed	180	6	.002	.003	.003	.004	.006	690	660	560	430	390	360
		tempered	275	7	.002	.003	.003	.004	.006	690	660	560	430	390	360
		tempered	300	8	.002	.003	.003	.004	.006	690	660	560	430	390	360
	High-alloyed steel and high-alloyed tool steel	annealed	200	10	.002	.002	.002	.003	.004	620	560	490	430	390	360
		hardened by tempering	325	11	.002	.002	.002	.003	.004	620	560	490	430	390	360
	Stainless steel	ferritic / martensitic, annealed	200	12	.002	.002	.003	.004	.005	520	460	390	430	390	360
		martensitic, tempered	240	13	.002	.002	.003	.004	.005	520	460	390	430	390	360
M	Stainless steel	austenitic2, retained	180	14	.002	.002	.003	.004	.005	660	590	520	520	490	460
K	Grey cast iron	pearlitic/ferritic	180	15	.003	.004	.005	.006	.006	460	430	390	390	390	360
		pearlitic (martensitic)	260	16	.003	.004	.005	.006	.006	460	430	390	390	390	360
	Cast iron with spheroidal graphite	ferritic	160	17	.002	.003	.005	.006	.006	390	390	360	360	360	330
		pearlitic	250	18	.002	.003	.005	.006	.006	390	390	360	360	360	330
	Malleable cast iron	ferritic	130	19	.003	.004	.004	.005	.006	460	430	390	390	390	360
		pearlitic	230	20	.003	.004	.004	.005	.006	460	430	390	390	390	360
N	Aluminum malleable alloys	non-age-hardenable	60	21	-	-	-	-	-	-	-	-	-	-	-
		age-hardenable, age-hardened	100	22	-	-	-	-	-	-	-	-	-	-	-
	Aluminum cast alloys	< 12% Si, non-age-hardenable	75	23	-	-	-	-	-	-	-	-	-	-	-
		< 12% Si, age-hardenable,-hardened	90	24	-	-	-	-	-	-	-	-	-	-	-
		> 12% Si, non-age-hardenable	130	25	-	-	-	-	-	-	-	-	-	-	-
	Copper and copper alloys (Bronze/brass)	Free cutting alloys, Pb > 1 %	110	26	-	-	-	-	-	-	-	-	-	-	-
		Brass, red brass	90	27	-	-	-	-	-	-	-	-	-	-	-
		Bronze unleaded & electrolytic copper	100	28	-	-	-	-	-	-	-	-	-	-	-
Non-metallic materials	Duroplasts	-	29	-	-	-	-	-	-	260	230	230	200	200	200
	fiber-reinforced plastics	-	-	-	-	-	-	-	-	260	230	230	200	200	200
	Hard rubber	-	30	-	-	-	-	-	-	160	130	130	130	130	130
S	Heat-resistant alloys	Fe basis annealed	200	31	.002	.002	.002	.002	.003	160	130	130	130	130	130
		age-hardened	280	32	.002	.002	.002	.002	.003	160	130	130	130	130	130
		Ni or annealed	250	33	-	-	.002	.002	.003	-	-	-	-	-	-
		Co basis age-hardened	350	34	-	-	.002	.002	.003	-	-	-	-	-	-
		cast	320	35	-	-	.002	.002	.003	-	-	-	-	-	-
	Titanium alloys	Pure titanium	4003	36	-	-	-	-	-	-	-	-	-	-	-
		Alpha + Beta alloys, age-hardened	10503	37	-	-	-	-	-	-	-	-	-	-	-

INDEXABLE DRILL TROUBLESHOOTING TIPS:

Inserts Chipping or Breaking-

- **Inadequate coolant supply-** Check coolant volume and pressure
- **Speeds and feeds being used are incorrect-** Adjust speed and feeds according to tables provided
- **Insert screws may be damaged-** Check screw head and thread for nicks and burrs. Do not overtighten screws
- **Inserts not seating properly-** Make sure the inserts are seated properly in the pocket bottoms. Clean insert pockets whenever inserts are replaced or indexed making sure no nicks or burrs are present.
- **Misaligned drill/offcenter drill-** Check toolholder TIR. Replace or adjust TIR as necessary.
- **Drill not seating properly in tool holder, spindle or turret-** Make sure there are no nicks, burrs or chips in tool shank and/or holder. Use a feeler gauge to check parting line between tool shank and socket.
- **Too much tool deflection or lack of tool rigidity due to too much tool overhang-** Check if tool can be held shorter.



Call Us Today For All Of Your Machine Tool Needs!

COOLANT INDUCED TOOLHOLDERS

For mounting drills on machine tools & machining centers where there is no provision for feeding coolant through the machine spindle.

FEATURES:

- Add performance and life to cutting tools
- Reduced wear means higher consistency and tighter tolerances
- All holders come complete with coolant connection
- 750 SFM/200 PSI on "O" rings
- Coolant induced collars and replacement parts available

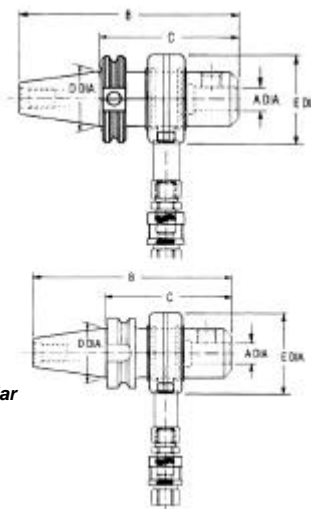

Includes Toolholder and Coolant Collar



CAT V-Flange Shank

Shank	A Hole Size	B Dim	C Proj.	D Gage Line Dia	E Dia.	Part Number	Price Each
CAT 40	3/4	7.13	4.44	1.75	2.83	C40-75CIH444-C	\$220.41
	1	8.68	6.00	1.75	3.59	C40-10CIH600-C	\$255.60
	1-1/4	8.38	5.69	1.75	3.59	C40-12CIH569-C	\$240.57
CAT 50	3/4	8.56	4.56	2.75	2.83	C50-75CIH456-C	\$325.89
	1	10.00	6.00	2.75	3.59	C50-10CIH600-C	\$384.40
	1-1/4	9.69	5.69	2.75	3.59	C50-12CIH569-C	\$365.13
	1-1/2	9.75	5.75	2.75	3.96	C50-15CIH575-C	\$391.05

BT Shank

Shank	A Hole Size	B Dim	C Proj.	D Gage Line Dia	E Dia.	Part Number	Price Each
BT30	3/4	6.74	4.56	1.25	2.83	B30-75CIH456-C	\$230.04
BT 40	3/4	7.01	4.44	1.75	2.83	B40-75CIH444-C	\$235.71
	1-1/4	8.26	5.69	1.75	3.59	B40-12CIH569-C	\$250.11
BT 45	3/4	7.82	4.56	2.25	2.83	B45-75CIH456-C	\$320.13
	1-1/4	8.95	5.69	2.25	3.59	B45-12CIH569-C	\$330.66
BT 50	3/4	8.57	4.56	2.75	2.83	B50-75CIH456-C	\$330.66
	1-1/4	9.70	5.69	2.75	3.59	B50-12CIH569-C	\$350.73
	1-1/2	9.76	5.75	2.75	3.96	B50-15CIH575-C	\$410.22

KOMET COATED AND UNCOATED INSERTS GRADES AND SPEED/FEED INFORMATION

KOMET™

Komet Grade	Application
BK84	An TiCN/TiN-PVD coated grade which combines toughness with good wear resistance. For machining steel, cast steel and stainless steel. Because of the PVD coating, BK84 is the preferred grade for internal inserts for insert drills (less build-up on cutting edges). BK84 is also suitable for external inserts on insert
P 40	Uncoated carbide with medium wear resistance at optimum toughness factor. Low to medium cutting speeds for roughing and with heavily interrupted cut. Also for unstable working conditions. For non-alloy steel, die steel and stainless steels
K 10	Chamfered and neutral cutter geometry suitable for all grades of cast iron. Positively Molded (PD) and ground geometry is used for aluminum. E.g.:20 ° top rake, ground, Sharply and light honed.
BK 62	TiCN and Al2O3-CVD-coating for higher cutting speeds in all types of cast iron materials. Only limited suitability for extreme interrupted cut. Not suitable for Aluminum materials.

KOMET Coated And Uncoated Inserts Speed-Feed Information

Helpful formula:
rpm=(3.82 X SFM)/(tool diameter)

Material	Hardness (HB)	Speed (sfm)	Feed (ipr)					
			Boring Depth 2x Dia / 3x Dia			Boring Depth 4x Dia		
			Drill Dia .750-.937	Drill Dia 1.000-1.750	Drill Dia >1.750	Drill Dia .750	Drill Dia .812-.937	Drill Dia 1.000-1.750
Mild steel	Up To 150	760-990	.003-.005	.003-.006	.004-.006	.001-.003	.002-.004	.002-.005
Free cutting steel	Up To 150	660-930	.003-.006	.004-.007	.005-.008	.002-.004	.002-.005	.003-.006
Mild case-hardened and heat-treated steel	150-220	600-825	.003-.005	.003-.006	.004-.006	.002-.003	.002-.004	.002-.005
Heat steel alloyed Cr and CrMo steel	200-260	460-660	.002-.005	.003-.006	.004-.006	.002-.003	.002-.004	.003-.005
Tool and heat-treated steels	<250	460-660	.002-.004	.002-.005	.004-.006	.001-.002	.002-.003	.002-.004
	360-560	330-500	.002-.003	.002-.004	.002-.005	.001-.002	.001-.002	.002-.003
Stainless and heat-resistant steels Cr,CrNiu,CrNiMo-alloys	150-270	400-600	.002-.005	.003-.006	.004-.008	.002-.003	.002-.004	.002-.005
Hardened steels	Over 480	65-200	.002-.003	.002-.004	.002-.004	.001-.002	.001-.002	.002-.003
Cast steel	Upto 200	500-825	.002-.005	.003-.006	.004-.008	.002-.003	.002-.004	.002-.005
Cast iron	180-250	330-660	.004-.006	.005-.008	.006-.010	.003-.005	.003-.006	.004-.006
High strength cast iron/alloy cast iron	Over 250	330-500	.003-.005	.003-.006	.004-.008	.002-.003	.002-.004	.002-.006
Aluminium alloys	Upto 80	825-1480	.002-.004	.002-.005	.003-.006	.001-.002	.002-.003	.002-.004
	80-120	660-990	.002-.005	.003-.006	.004-.006	.002-.003	.002-.004	.002-.005
	Over 120	500-825	.003-.005	.004-.006	.005-.008	.002-.003	.002-.004	.003-.006
Heat resistant super alloy (Cobalt based)		65-260	.001-.003	.002-.004	.002-.005	.001-.002	.001-.002	.002-.003
Plastics solid		500-990	.004-.006	.004-.006	.005-.008	.002-.005	.003-.005	.003-.006

KOMET is a registered trademark of KOMET of America

Call Us Or Visit Our Website For Our Complete Selection!