

CAT-40 TAP HOLDERS & TAP COLLETS

V-FLANGE TAP HOLDERS

Tension / Compression and Synchronous Tapping
For use with Industry Standard Quick-Change Tap Collets

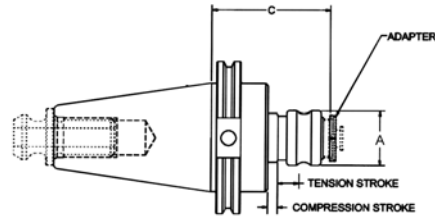

Adapter Size	Capacity	C Proj	Comp	Tension	A Dia	Brand	Part Number	Price Each	Code
--------------	----------	--------	------	---------	-------	-------	-------------	------------	------

Rigid Tapping

1	#0 - 9/16" Hand, 1/16" & 1/8" NPT	3.000	0.300	0.300	1.250	STS	C40-10TA300-U	\$190.00	D
		3.960	0.250	0.560	1.390	Parlec	C40-10TA396-P	\$268.20	B
	#0 - 9/16" Hand, 1/8" NPT	4.000	0.290	0.290	1.430	Sowa	C40-10TA400-G	\$251.91	C
		4.560	0.370	-	.75	Command	C40-10TA456-M	\$224.84	C
2	5/16" - 7/8" Hand, 1/4", 3/8" & 1/2" NPT	3.810	0.492	0.492	1.960	STS	C40-20TA381-U	\$219.00	D
		4.500	0.490	0.490	2.090	Sowa	C40-20TA450-G	\$231.52	C
	6.470	0.370	-	.75	Command	C40-20TA647-M	\$261.94	C	
3	13/16" - 1 3/8" Hand, 3/4" - 1" NPT	5.780	0.787	0.787	3.070	STS	C40-30TA578-U	\$375.00	D
		6.460	0.250	0.560	3.260	Parlec	C40-30TA646-P	\$352.80	

Rigid Tapping

1	#0 - 9/16" Hand, 1/8" NPT	3.020	Rigid	Rigid	1.250	Sowa	C40-10FS302-G	\$120.00	C
		3.440	Rigid	Rigid	1.250	STS	C40-10FS344-U	\$162.50	D
	#0 - 9/16" Hand, 1/16" & 1/8" NPT	3.580	Rigid	Rigid	-	Command	C50-10TR358-M	\$233.03	C
		3.960	Rigid	Rigid	1.390	Parlec	C40-10TR396-P	\$244.80	B
2	5/16" - 7/8" Hand, 1/4", 3/8" & 1/2" NPT	3.430	Rigid	Rigid	1.960	STS	C40-20FS343-U	\$175.00	D
		3.660	Rigid	Rigid	2.000	Sowa	C40-20FS366-G	\$135.96	C
	5/16" - 7/8" Hand, 1/4" - 1/2" NPT	3.860	Rigid	Rigid	2.180	Parlec	C40-20TR386-P	\$292.50	B
		4.220	Rigid	Rigid	-	Command	C40-20TR422-M	\$257.53	C
3	13/16" - 1 3/8" Hand, 1/2" - 1" NPT	4.720	Rigid	Rigid	2.870	Sowa	C40-30FS472-G	\$163.32	C
		4.720	Rigid	Rigid	2.830	STS	C40-30FS472-U	\$247.50	D

TAP ADAPTERS/TAP COLLETS

- Interchangeable with industry standard tapping systems.
- Quick change feature saves you time
- **Torque Controlled** tap adapters are ideal for blind hole tapping to protect your taps and workpieces from tap breakage.
- **Positive Drive** adapters are best suited for through hole tapping applications.
- Quantity discounts!



TAP SIZE	SIZE 1 (A=0.75)				SIZE 2 (A=1.22)			
	POSITIVE DRIVE		TORQUE CONTROLLED		POSITIVE DRIVE		TORQUE CONTROLLED	
	STS \$24.00 ea	BILZ \$32.00 ea	STS \$60.00 ea	BILZ \$82.00 ea	STS \$35.00 ea	BILZ \$49.00 ea	STS \$97.00 ea	BILZ \$130.00 ea
#0-6, M2,M3	BZ10-6P	BZ10-6P-Z	BZ10-6T	BZ10-6T-Z	BZ20-6P	-	-	-
#8, M4	BZ10-8P	BZ10-8P-Z	BZ10-8T	BZ10-8T-Z	BZ20-8P	-	-	-
#10, M4.5,M5	BZ10-10P	BZ10-10P-Z	BZ10-10T	BZ10-10T-Z	BZ20-10P	-	-	-
#12	BZ10-12P	BZ10-12P-Z	BZ10-12T	BZ10-12T-Z	BZ20-12P	-	-	-
1/4", M6	BZ10-025P	BZ10-025P-Z	BZ10-025T	BZ10-025T-Z	BZ20-25P	BZ20-25P-Z	-	-
5/16", M7,M8	BZ10-031P	BZ10-031P-Z	BZ10-031T	BZ10-031T-Z	BZ20-031P	BZ20-031P-Z	BZ20-031T	BZ20-031T-Z
3/8", M10	BZ10-037P	BZ10-037P-Z	BZ10-037T	BZ10-037T-Z	BZ20-037P	BZ20-037P-Z	BZ20-037T	BZ20-037T-Z
7/16"	BZ10-043P	BZ10-043P-Z	BZ10-043T	BZ10-043T-Z	BZ20-043P	BZ20-043P-Z	BZ20-043T	BZ20-043T-Z
1/2", M12	BZ10-050P	BZ10-050P-Z	BZ10-050T	BZ10-050T-Z	BZ20-050P	BZ20-050P-Z	BZ20-050T	BZ20-050T-Z
9/16", M14	BZ10-056P	BZ10-056P-Z	BZ10-056T	BZ10-056T-Z	BZ20-056P	BZ20-056P-Z	BZ20-056T	BZ20-056T-Z
5/8", M16	-	-	-	-	BZ20-062P	BZ20-062P-Z	BZ20-062T	BZ20-062T-Z
11/16", M18	-	-	-	-	BZ20-068P	BZ20-068P-Z	BZ20-068T	BZ20-068T-Z
3/4"	-	-	-	-	BZ20-075P	BZ20-075P-Z	BZ20-075T	BZ20-075T-Z
13/16", M20	-	-	-	-	BZ20-081P	BZ20-081P-Z	BZ20-081T	BZ20-081T-Z
7/8", M22	-	-	-	-	BZ20-087P	BZ20-087P-Z	BZ20-087T	BZ20-087T-Z
1/16" NPT	BZ10-006NP	BZ10-006NP-Z	BZ10-006NT	BZ10-006NT-Z	-	-	-	-
1/8" NPT	BZ10-012NP	BZ10-012NP-Z	BZ10-012NT	BZ10-012NT-Z	-	-	-	-
1/4" NPT	-	-	-	-	BZ20-025NP	BZ20-025NP-Z	BZ20-025NT	BZ20-025NT-Z
3/8" NPT	-	-	-	-	BZ20-037NP	BZ20-037NP-Z	BZ20-037NT	BZ20-037NT-Z
1/2" NPT	-	-	-	-	BZ20-050NP	BZ20-050NP-Z	BZ20-050NT	BZ20-050NT-Z

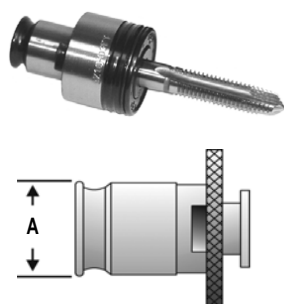

QUANTITY DISCOUNTS	
5-9 Pcs	5% Off
10+ Pcs	10% Off

Call Us Or Visit Our Website For Our Complete Selection!

LATHE CHUCKS
LIVE CENTERS

WISE ACCESSORIES
WISE JAWS

STRAIGHT SHANK
COLLET HOLDERS

LATHE BUSHINGS
DRILL CHUCKS

CARBIDE INSERTS
THREADING/GROOVING

CUTTING TOOLS
MACHINERY

PRECISION TOOLS
DEBURRING

COOLANT/FLUIDS
TOOL STORAGE

CHUCK JAWS
LATHE WORKHOLDING

MACHINE VISES
MAGNETIC CHUCKS

RETENTION KNOBS
ER, DA, TG COLLETS

TOOLHOLDERS
TAP HOLDERS

INDEXABLE DRILLS
TURNING & BORING

ENDMILLS, DRILLS
TAPS & REAMERS

ABRASIVES
MEASURING TOOLS

MRO & SAFETY
FLAT STOCK/DRILL ROD

CAT-50 V-FLANGE TAP HOLDERS

V-FLANGE TAP HOLDERS

Tension / Compression and Synchronous Tapping
For use with Industry Standard Quick-Change Tap Collets

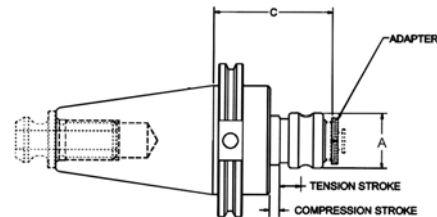

Adapter Size	Capacity	C Proj	Comp	Tension	A Dia	Brand	Part Number	Price Each	Code
--------------	----------	--------	------	---------	-------	-------	-------------	------------	------

Tension/Compression

1	#0 - 9/16" Hand, 1/16" & 1/8" NPT	3.15	0.250	0.560	1.390	Parlec	C50-10TA315-P	\$279.00	B
		3.52	0.300	0.300	1.417	STS	C50-10TA352-U	\$225.00	D
	#0 - 9/16" Hand, 1/8" NPT	4.00	0.290	0.290	1.430	Sowa	C50-10TA400-G	\$294.41	C
5.02		0.390	0.790	1.250	Sowa	C50-10TA502-G	\$254.13	C	
2	5/16" - 7/8" Hand, 1/4", 3/8" & 1/2" NPT	4.56	0.370	0.750	-	Command	C50-10TA456-M	\$247.10	B
		3.93	0.492	0.492	2.080	STS	C50-20TA393-U	\$300.00	D
	5/16" - 7/8" Hand, 1/4" - 1/2" NPT	4.25	0.250	0.560	2.180	Parlec	C50-20TA425-P	\$295.00	B
		4.50	0.490	0.490	2.090	Sowa	C50-20TA450-G	\$335.00	C
		5.66	0.490	0.850	2.000	Sowa	C50-20TA566-G	\$330.62	C
		5.82	0.370	0.750	-	Command	C50-20TA582-M	\$293.09	B
3	13/16" - 1 3/8" Hand, 3/4" - 1" NPT	5.65	0.250	0.560	3.260	Parlec	C50-30TA565-P	\$396.00	B
		5.78	0.787	0.787	3.070	STS	C50-30TA578-U	\$400.00	D
		6.19	0.380	0.880	2.830	Collis	C50-30TA619-C	\$294.42	C
	13/16" - 1 3/8" Hand, 1/2" - 1" NPT	6.25	0.790	0.790	3.070	Sowa	C50-30TA625-G	\$443.85	C
		7.72	0.590	0.980	2.870	Sowa	C50-30TA772-G	\$517.89	C
		8.33	0.370	0.750	-	Command	C50-30TA833-M	\$354.69	B

Rigid Tapping

1	#0 - 9/16" Hand, 1/8" NPT	3.020	Rigid	Rigid	1.250	Sowa	C50-10FS302-G	\$154.48	C
		3.150	Rigid	Rigid	1.390	Parlec	C50-10TR315-P	\$254.70	B
		3.440	Rigid	Rigid	1.250	STS	C50-10FS344-U	\$195.00	D
		3.58	Rigid	Rigid		Command	C50-10TR358-M	\$233.03	B
2	5/16"-7/8" Hand, 1/4", 3/8" & 1/2" NPT	3.540	Rigid	Rigid	1.960	STS	C50-20FS354-U	\$235.00	D
		5/16" - 7/8" Hand, 1/4" - 1/2" NPT	3.910	Rigid	Rigid	2.000	Sowa	C50-20FS391-G	\$156.70
	4.22		Rigid	Rigid	-	Command	C50-20TR422-M	\$280.49	B
	4.250		Rigid	Rigid	2.180	Parlec	C50-20TR425-P	\$305.10	B
3	13/16"-1 3/8" Hand, 1/2"-1" NPT	4.980	Rigid	Rigid	2.870	Sowa	C50-30FS498-G	\$248.24	C
		13/16" - 1 3/8" Hand, 3/4" - 1" NPT	8.33	Rigid	Rigid		Command	C50-30FS833-M	\$369.53
	4.720		Rigid	Rigid	2.830	STS	C50-30FS472-U	\$230.00	D
	5.650		Rigid	Rigid	3.260	Parlec	C50-30FS565-P	\$396.00	B

TAP ADAPTERS/TAP COLLETS

- Interchangeable with industry standard tapping systems.
- Quick change feature saves you time
- **Torque Controlled** tap adapters are ideal for blind hole tapping to protect your taps and workpieces from tap breakage.
- **Positive Drive** adapters are best suited for through hole tapping applications.
- Quantity discounts!

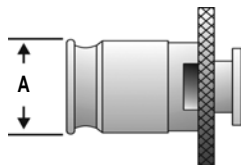

E

TAP SIZE	SIZE 1 (A=0.75)		SIZE 2 (A=1.22)		
	POSITIVE DRIVE	TORQUE CONTROLLED	POSITIVE DRIVE	TORQUE CONTROLLED	
	\$24.00 ea	\$60.00 ea	\$35.00 ea	\$97.00 ea	
#0-6, M2,M3 #8, M4	BZ10-6P	BZ10-6T	BZ20-6P	-	
	BZ10-8P	BZ10-8T	BZ20-8P	-	
	BZ10-10P	BZ10-10T	BZ20-10P	-	
#10, M4.5,M5 #12	BZ10-12P	BZ10-12T	BZ20-12P	-	
	1/4", M6 5/16", M7,M8	BZ10-025P	BZ10-025T	BZ20-25P	-
		BZ10-031P	BZ10-031T	BZ20-031P	BZ20-031T
3/8", M10 7/16"	BZ10-037P	BZ10-037T	BZ20-037P	BZ20-037T	
	BZ10-043P	BZ10-043T	BZ20-043P	BZ20-043T	
1/2", M12 9/16", M14	BZ10-050P	BZ10-050T	BZ20-050P	BZ20-050T	
	BZ10-056P	BZ10-056T	BZ20-056P	BZ20-056T	
5/8", M16 11/16", M18 3/4"	-	-	BZ20-062P	BZ20-062T	
	-	-	BZ20-068P	BZ20-068T	
	-	-	BZ20-075P	BZ20-075T	

Call Us Today For All Of Your Machine Tool Needs!

2010-11 Master Catalog

BT-40 TAP HOLDERS

V-FLANGE TAP HOLDERS

Tension / Compression and Synchronous Tapping
For use with Industry Standard Quick-Change Tap Collets

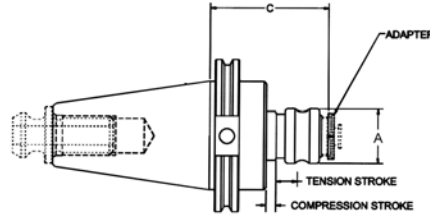

Adapter Size	Capacity	C Proj.	Comp.	Tension	A Dia	Brand	Part Number	Price Each	Code
1	#0 - 9/16" Hand, 1/16" & 1/8" NPT	2.650	0.295	0.295	1.417	STS	B40-10TA265-U	\$200.00	D
		4.080	0.250	0.560	1.390	Parlec	B40-10TA408-P	\$265.50	B
	#0 - 9/16" Hand, 1/8" NPT	3.800	0.290	0.290	1.430	Sowa	B40-10TA380-G	\$217.21	C
		3.31	0.370	-	0.75	Command	B40-10TA331-M	\$216.72	B
2	5/16" - 7/8" Hand, 1/4", 3/8" & 1/2" NPT	3.720	0.492	0.492	2.087	STS	B40-20TA372-U	\$262.50	D
		4.01	0.370	-	.75	Command	B40-20TA401-M	\$261.94	B
	5/16" - 7/8" Hand, 1/4" - 1/2" NPT	4.500	0.490	0.490	2.090	Sowa	B40-20TA450-G	\$273.68	C
		5.190	0.250	0.560	2.180	Parlec	B40-20TA519-P	\$315.00	B
3	13/16"-1-3/8" Hand, 3/4"-1" NPT	6.450	0.787	0.787	3.070	STS	B40-30TA645-U	\$375.00	D
	13/16" - 1 3/8" Hand, 1/2" - 1" NPT	7.500	0.790	0.790	3.070	Sowa	B40-30TA750-G	\$325.19	C

TAP ADAPTERS/TAP COLLETS

- Interchangeable with industry standard tapping systems.
- Quick change feature saves you time
- **Torque Controlled** tap adapters are ideal for blind hole tapping to protect your taps and workpieces from tap breakage.
- **Positive Drive** adapters are best suited for through hole tapping applications.
- Quantity discounts!



TAP SIZE	SIZE 1 (A=0.75)				SIZE 2 (A=1.22)			
	POSITIVE DRIVE		TORQUE CONTROLLED		POSITIVE DRIVE		TORQUE CONTROLLED	
	STS \$24.00 ea	BILZ \$32.00 ea	STS \$60.00 ea	BILZ \$82.00 ea	STS \$35.00 ea	BILZ \$49.00 ea	STS \$97.00 ea	BILZ \$130.00 ea
#0-6, M2,M3	BZ10-6P	BZ10-6P-Z	BZ10-6T	BZ10-6T-Z	BZ20-6P	-	-	-
#8, M4	BZ10-8P	BZ10-8P-Z	BZ10-8T	BZ10-8T-Z	BZ20-8P	-	-	-
#10, M4.5,M5	BZ10-10P	BZ10-10P-Z	BZ10-10T	BZ10-10T-Z	BZ20-10P	-	-	-
#12	BZ10-12P	BZ10-12P-Z	BZ10-12T	BZ10-12T-Z	BZ20-12P	-	-	-
1/4", M6	BZ10-025P	BZ10-025P-Z	BZ10-025T	BZ10-025T-Z	BZ20-25P	BZ20-25P-Z	-	-
5/16", M7,M8	BZ10-031P	BZ10-031P-Z	BZ10-031T	BZ10-031T-Z	BZ20-031P	BZ20-031P-Z	BZ20-031T	BZ20-031T-Z
3/8", M10	BZ10-037P	BZ10-037P-Z	BZ10-037T	BZ10-037T-Z	BZ20-037P	BZ20-037P-Z	BZ20-037T	BZ20-037T-Z
7/16"	BZ10-043P	BZ10-043P-Z	BZ10-043T	BZ10-043T-Z	BZ20-043P	BZ20-043P-Z	BZ20-043T	BZ20-043T-Z
1/2", M12	BZ10-050P	BZ10-050P-Z	BZ10-050T	BZ10-050T-Z	BZ20-050P	BZ20-050P-Z	BZ20-050T	BZ20-050T-Z
9/16", M14	BZ10-056P	BZ10-056P-Z	BZ10-056T	BZ10-056T-Z	BZ20-056P	BZ20-056P-Z	BZ20-056T	BZ20-056T-Z
5/8", M16	-	-	-	-	BZ20-062P	BZ20-062P-Z	BZ20-062T	BZ20-062T-Z
11/16", M18	-	-	-	-	BZ20-068P	BZ20-068P-Z	BZ20-068T	BZ20-068T-Z
3/4"	-	-	-	-	BZ20-075P	BZ20-075P-Z	BZ20-075T	BZ20-075T-Z
13/16", M20	-	-	-	-	BZ20-081P	BZ20-081P-Z	BZ20-081T	BZ20-081T-Z
7/8", M22	-	-	-	-	BZ20-087P	BZ20-087P-Z	BZ20-087T	BZ20-087T-Z
1/16" NPT	BZ10-006NP	BZ10-006NP-Z	BZ10-006NT	BZ10-006NT-Z	-	-	-	-
1/8" NPT	BZ10-012NP	BZ10-012NP-Z	BZ10-012NT	BZ10-012NT-Z	-	-	-	-
1/4" NPT	-	-	-	-	BZ20-025NP	BZ20-025NP-Z	BZ20-025NT	BZ20-025NT-Z
3/8" NPT	-	-	-	-	BZ20-037NP	BZ20-037NP-Z	BZ20-037NT	BZ20-037NT-Z
1/2" NPT	-	-	-	-	BZ20-050NP	BZ20-050NP-Z	BZ20-050NT	BZ20-050NT-Z

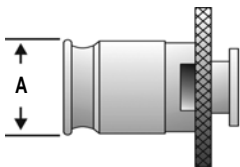

QUANTITY DISCOUNTS	
5-9 Pcs	5% Off
10+ Pcs	10% Off

Call Us Or Visit Our Website For Our Complete Selection!

2010-11 Master Catalog

225

LATHES CHUCKS
LIVE CENTERS

WISE JAWS
WISE ACCESSORIES

STRAIGHT SHANK
COLLET HOLDERS

LATHES BUSHINGS
DRILL CHUCKS

CARBIDE INSERTS
THREADING/GROOVING

CUTTING TOOLS
MACHINERY

PRECISION TOOLS
DEBURRING

COOLANT/FLUIDS
TOOL STORAGE

TAP ADAPTERS/COLLETS

TAP ADAPTERS/TAP COLLETS

- Interchangeable with industry standard tapping systems.
- Quick change feature saves you time
- **Torque Controlled** tap adapters are ideal for blind hole tapping to protect your taps and workpieces from tap breakage.
- **Positive Drive** adapters are best suited for through hole tapping applications.
- Quantity discounts!

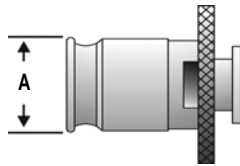

TAP SIZE	SIZE 0 (A=0.51)				SIZE 1 (A=0.75)			
	POSITIVE DRIVE		TORQUE CONTROLLED		POSITIVE DRIVE		TORQUE CONTROLLED	
	STS \$24.00 ea	BILZ \$38.00 ea	STS \$60.00 ea	BILZ \$85.00 ea	STS \$24.00 ea	BILZ \$32.00 ea	STS \$60.00 ea	BILZ \$82.00 ea
#0-6, M2,M3	BZ00-6P	BZ00-6P-Z	BZ00-6T	BZ00-6T-Z	BZ10-6P	BZ10-6P-Z	BZ10-6T	BZ10-6T-Z
#8, M4	BZ00-8P	BZ00-8P-Z	BZ00-8T	BZ00-8T-Z	BZ10-8P	BZ10-8P-Z	BZ10-8T	BZ10-8T-Z
#10, M4.5,M5	BZ00-10P	BZ00-10P-Z	BZ00-10T	BZ00-10T-Z	BZ10-10P	BZ10-10P-Z	BZ10-10T	BZ10-10T-Z
#12	BZ00-12P	BZ00-12P-Z	BZ00-12T	BZ00-12T-Z	BZ10-12P	BZ10-12P-Z	BZ10-12T	BZ10-12T-Z
1/4", M6	BZ00-025P	BZ00-025P-Z	BZ00-025T	BZ00-025T-Z	BZ10-025P	BZ10-025P-Z	BZ10-025T	BZ10-025T-Z
5/16", M7,M8	BZ00-031P	BZ00-031P-Z	BZ00-031T	BZ00-031T-Z	BZ10-031P	BZ10-031P-Z	BZ10-031T	BZ10-031T-Z
3/8", M10	-	-	-	-	BZ10-037P	BZ10-037P-Z	BZ10-037T	BZ10-037T-Z
7/16"	-	-	-	-	BZ10-043P	BZ10-043P-Z	BZ10-043T	BZ10-043T-Z
1/2", M12	-	-	-	-	BZ10-050P	BZ10-050P-Z	BZ10-050T	BZ10-050T-Z
9/16", M14	-	-	-	-	BZ10-056P	BZ10-056P-Z	BZ10-056T	BZ10-056T-Z
1/16" NPT	-	-	-	-	BZ10-006NP	BZ10-006NP-Z	BZ10-006NT	BZ10-006NT-Z
1/8" NPT	-	-	-	-	BZ10-012NP	BZ10-012NP-Z	BZ10-012NT	BZ10-012NT-Z
SETS	BZ00P-SET6	-	BZ00T-SET6	-	BZ10P-SET12	-	BZ10T-SET12	-
1 of each	\$129.60	-	\$324.00	-	\$259.20	-	\$648.00	-

TAP SIZE	SIZE 2 (A=1.22)				SIZE 3 (A=1.89)	
	POSITIVE DRIVE		TORQUE CONTROLLED		POSITIVE DRIVE	
	STS \$35.00 ea	BILZ \$49.00 ea	STS \$97.00 ea	BILZ \$130.00 ea	STS \$84.00 ea	BILZ \$135.00 ea
#0-6, M2,M3	BZ20-6P	-	-	-	-	-
#8, M4	BZ20-8P	-	-	-	-	-
#10, M4.5,M5	BZ20-10P	-	-	-	-	-
#12	BZ20-12P	-	-	-	-	-
1/4", M6	BZ20-25P	BZ20-25P-Z	-	-	-	-
5/16", M7,M8	BZ20-031P	BZ20-031P-Z	BZ20-031T	BZ20-031T-Z	-	-
3/8", M10	BZ20-037P	BZ20-037P-Z	BZ20-037T	BZ20-037T-Z	-	-
7/16"	BZ20-043P	BZ20-043P-Z	BZ20-043T	BZ20-043T-Z	-	-
1/2", M12	BZ20-050P	BZ20-050P-Z	BZ20-050T	BZ20-050T-Z	-	-
9/16", M14	BZ20-056P	BZ20-056P-Z	BZ20-056T	BZ20-056T-Z	-	-
5/8", M16	BZ20-062P	BZ20-062P-Z	BZ20-062T	BZ20-062T-Z	-	-
11/16", M18	BZ20-068P	BZ20-068P-Z	BZ20-068T	BZ20-068T-Z	-	-
3/4"	BZ20-075P	BZ20-075P-Z	BZ20-075T	BZ20-075T-Z	-	-
13/16", M20	BZ20-081P	BZ20-081P-Z	BZ20-081T	BZ20-081T-Z	BZ30-081P	BZ30-081P-Z
7/8", M22	BZ20-087P	BZ20-087P-Z	BZ20-087T	BZ20-087T-Z	BZ30-087P	BZ30-087P-Z
15/16", M24	-	-	-	-	BZ30-093P	BZ30-093P-Z
1", M25	-	-	-	-	BZ30-100P	BZ30-100P-Z
1-1/8", M27	-	-	-	-	BZ30-112P	BZ30-112P-Z
1-1/4", M30	-	-	-	-	BZ30-125P	BZ30-125P-Z
1-3/8", M33	-	-	-	-	BZ30-137P	BZ30-137P-Z
1/4" NPT	BZ20-025NP	BZ20-025NP-Z	BZ20-025NT	BZ20-025NT-Z	-	-
3/8" NPT	BZ20-037NP	BZ20-037NP-Z	BZ20-037NT	BZ20-037NT-Z	-	-
1/2" NPT	BZ20-050NP	BZ20-050NP-Z	BZ20-050NT	BZ20-050NT-Z	-	\$156.00 ea
3/4" NPT	-	-	-	-	BZ30-075NP	BZ30-075NP-Z
1" NPT	-	-	-	-	BZ30-100NP	BZ30-100NP-Z
SETS	BZ20P-SET18	-	BZ20T-SET13	-	BZ30P-SET9	BZ30P-SET9-Z
1 of each	\$567.00	-	\$1134.90	-	\$680.40	-



Torque Controlled



STS QTY DISCOUNTS

QUANTITY DISCOUNTS	
5-9 Pcs	5% Off
10+ Pcs	10% Off

Call Us Today For All Of Your Machine Tool Needs!

BILZ STYLE ADAPTERS/TAP HOLDERS

LATHES CHUCKS
LIVE CENTERS

WISE JAWS
WISE ACCESSORIES

STRAIGHT SHANK
COLLET HOLDERS

LATHES BUSHINGS
DRILL CHUCKS

CARBIDE INSERTS
THREADING/GROOVING

CUTTING TOOLS
MACHINERY

PRECISION TOOLS
DEBURRING

COOLANT/FLUIDS
TOOL STORAGE

V-FLANGE TAP HOLDERS

Tension / Compression and Synchronous Tapping
For use with Industry Standard Quick-Change Tap Collets

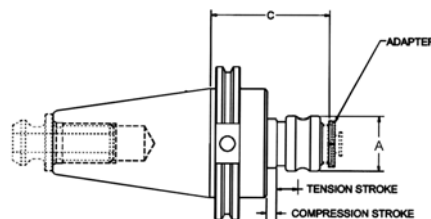

Adapter Size	Capacity	C Proj.	Comp.	Tension	A Dia	Brand	Part Number	Price Each	With Coolant Hole	Code
--------------	----------	---------	-------	---------	-------	-------	-------------	------------	-------------------	------

Tension/Compression

1	#0 - 9/16" Hand, 1/16" & 1/8" NPT	3.000	0.300	0.300	1.250	STS	C40-10TA300-U	\$190.00	-	D
		3.110	0.380	0.880	1.250	Collis	C40-10TA311-C	\$186.34	-	C
		3.960	0.250	0.560	1.390	Parlec	C40-10TA396-P	\$232.20	C40-10TA396C-P	B
	#0 - 9/16" Hand, 1/8" NPT	4.000	0.290	0.290	1.430	Sowa	C40-10TA400-G	\$203.92	-	C
4.470		0.390	0.790	1.250	Sowa	C40-10TA447-G	\$215.33	-	C	
2	5/16" - 7/8" Hand, 1/4", 3/8" & 1/2" NPT	3.810	0.492	0.492	1.960	STS	C40-20TA381-U	\$262.50	-	D
		4.050	0.380	0.880	1.960	Collis	C40-20TA405-C	\$219.87	-	C
	5/16" - 7/8" Hand, 1/4" - 1/2" NPT	4.500	0.490	0.490	2.090	Sowa	C40-20TA450-G	\$231.51	-	C
		5.060	0.250	0.560	2.180	Parlec	C40-20TA506-P	\$274.50	C40-20TA506C-P	B
6.660	0.490	0.850	2.000	Sowa	C40-20TA666-G	\$248.90	-	C		
	13/16" - 1 3/8" Hand, 3/4" - 1" NPT	5.780	0.787	0.787	3.070	STS	C40-30TA578-U	\$375.00	-	D
6.460		0.250	0.560	3.260	Parlec	C40-30TA646-P	\$306.00	C40-30TA646C-P	B	
8.000	0.790	0.790	3.070	Sowa	C40-30TA800-G	\$325.19	-	C		
	9.190	0.590	0.980	2.870	Sowa	C40-30TA919-G	\$351.19	-	C	

Rigid Tapping

1	#0 - 9/16" Hand, 1/8" NPT	3.020	Rigid	Rigid	1.250	Sowa	C40-10FS302-G	\$178.75	-	C
		3.440	Rigid	Rigid	1.250	Collis	C40-10FS344-C	\$171.43	-	C
		3.440	Rigid	Rigid	1.250	STS	C40-10FS344-U	\$162.50	-	D
	3.960	Rigid	Rigid	1.390	Parlec	C40-10TR396-P	\$211.50	C40-10TR396C-P	B	
2	5/16" - 7/8" Hand, 1/4", 3/8" & 1/2" NPT	3.430	Rigid	Rigid	1.960	USST	C40-20FS343-U	\$175.00	-	D
		3.540	Rigid	Rigid	1.960	Collis	C40-20FS345-C	\$187.11	-	C
	5/16" - 7/8" Hand, 1/4" - 1/2" NPT	3.660	Rigid	Rigid	2.000	Sowa	C40-20FS366-G	\$115.57	-	C
		3.860	Rigid	Rigid	2.180	Parlec	C40-20TR386-P	\$253.80	C40-20TR386C-P	B
4.720	13/16" - 1 3/8" Hand,	4.720	Rigid	Rigid	2.870	Sowa	C40-30FS472-G	\$132.21	-	C
	13/16" - 1 3/8" Hand, 3/4" - 1" NPT	4.720	Rigid	Rigid	2.830	STS	C40-30FS472-U	\$247.50	-	D
6.460	Rigid	Rigid	3.260	Parlec	C40-30FS646-P	\$306.00	C40-30FS646C-P	B		

STRAIGHT SHANK TAP HOLDERS

Synchronous:

Modern machine tools have the capability of synchronizing the spindle rotation and spindle feed. This has made it possible to eliminate the spring compression and tension stroke utilized in traditional tapping heads. The advantage that this brings to threading is the speed by which the cycle can operate.

Tension/Compression:

Tension and compression holders have been the mainstay of machine tool tapping for many years.

These holders are for use with Bilz style tapping collets, located on page 238



Rigid Tap Holders

Adapter Size	Shank	Proj. Length	Collar Dia	COLLIS [B]		STS [D]	
				Part Number	Price	Part Number	Price
#1	1"	1.60	1.42	COL-78358	\$213.93	ST-S10-10FS1-U	\$125.00
#2	1"	2.50	2.09	COL-78359	\$239.60	ST-S10-20FS2-U	\$145.00
#3	1-1/2"	3.78	3.08	COL-78360	\$319.50	ST-S15-30FS3-U	\$205.00

Tension Compression Tap Holders

Adapter Size	Tap Size	Shank	Proj. Length	Collar Dia	Comp.	Tens.	Brand	Part Number	Price	Code
#1	0 - 9/16	1"	1.60	1.42	.300	.300	STS	ST-S10-10TA1-U	\$185.00	D
							Collis	COL-78375	\$276.90	B
							Bilz	ST-S10-10TA1-BZ	\$263.00	B
#2	5/16 - 7/8	1"	2.50	2.09	.490	.490	STS	ST-S10-20TA2-U	\$199.00	D
							Collis	COL-78376	\$330.10	B
#3	13/16 - 1 3/8	1-1/2"	3.78	3.08	.790	.790	STS	ST-S15-30TA3-U	\$370.00	D
							Collis	COL-78377	\$457.90	B

Call Us Or Visit Our Website For Our Complete Selection!

BILZ QUICK CHANGE TAP HOLDERS

QUICK CHANGE TAP HOLDERS For Rigid Tapping, Internal Coolant

- Internal coolant tap holders for Rigid applications
- Coolant thru (50 bar/ 725 psi)
- CAT & BT Tapers
- Holders for Size 3 adapters also available

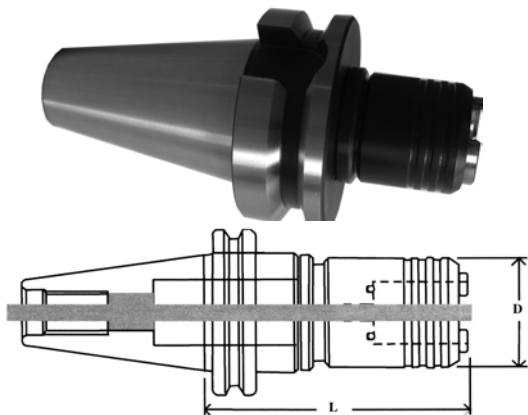

Adapter Size	Tap Range	Dia D	Proj L	Flange Taper	Part Number	Price Each
1	0- 9/16", M3-M12, 1/8" NPT	1.260	2.90	CAT 40	C40-10FS290-IZ	\$265.00
		1.260	2.90	CAT 50	C50-10FS290-IZ	\$290.00
		1.260	2.90	BT 40	B40-10FS290-IZ	\$265.00
		1.260	3.03	BT 50	B50-10FS303-IZ	\$290.00
2	1/4"-7/8", M8-M20, 1/8"-1/2" NPT	1.968	3.50	CAT 40	C40-20FS350-IZ	\$310.00
		1.968	3.50	CAT 50	C50-20FS350-IZ	\$335.00
		1.968	3.50	BT 40	B40-20FS350-IZ	\$310.00
		1.968	3.63	BT 50	B50-20FS363-IZ	\$335.00
3	13/16"-1-3/8", M14-M33, 1/2"-1" NPT	2.812	4.81	CAT 50	C50-30FS481-IZ	\$575.00
		2.812	5.31	BT 50	B50-30FS531-IZ	\$575.00

QUICK CHANGE TAP HOLDERS Tension/Compression

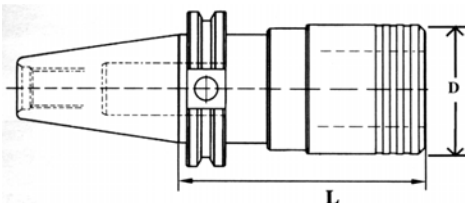

Adapter Size	Tap Range	Comp.	Tension	Dia D	Proj L	Flange Taper	Part Number	Price Each
0	0-5/16", M1-M10	0.260	0.260	1.024	2.75	CAT 40	C40-00TA275-MZ	\$355.00
		0.260	0.260	1.024	2.955	CAT 50	C50-00TA295-MZ	\$375.00
		0.260	0.260	1.024	2.455	BT 40	B40-00TA245-MZ	\$363.00
		0.260	0.260	1.024	4.355	BT 50	B50-00TA435-MZ	\$420.00
1	0- 9/16", M3-M12, 1/8" NPT	0.300	0.300	1.417	2.955	CAT 40	C40-10TA295-MZ	\$327.00
		0.300	0.300	1.417	3.855	CAT 50	C50-10TA385-MZ	\$347.00
		0.300	0.300	1.417	2.642	BT 40	B40-10TA264-MZ	\$334.00
		0.300	0.300	1.417	4.355	BT 50	B50-10TA435-MZ	\$392.00
2	1/4"-7/8", M8-M20, 1/8"-1/2" NPT	0.490	0.490	2.087	3.855	CAT 40	C40-20TA385-MZ	\$350.00
		0.490	0.490	2.087	3.855	CAT 50	C50-20TA385-MZ	\$370.00
		0.490	0.490	2.087	3.542	BT 40	B40-20TA354-MZ	\$357.00
		0.490	0.490	2.087	4.355	BT 50	B50-20TA435-MZ	\$415.00
3	13/16"-1-3/8", M14-M33, 1/2"-1" NPT	0.790	0.790	3.071	5.780	CAT 50	C50-30TA578-MZ	\$553.00
		0.790	0.790	3.071	5.655	BT 50	B50-30TA565-MZ	\$570.00
4	1 3/8"-1-7/8", M22-M48, 3/4"-1-1/2"	0.890	0.890	3.78	6.41	CAT 50	C50-40TA641-MZ	\$869.00
		0.890	0.890	3.78	6.988	BT 50	B50-40TA698-MZ	\$887.00

QUICK CHANGE STRAIGHT SHANK TAP CHUCK & ADAPTER SETS Rigid or Tension/Compression



Sets Include:
1 Straight Shank Holder
1 Each of the following adapters:
#6, #8, #10, #12, 1/4, 5/16, 3/8, 7/16, 1/2 & 9/16

Description	Part Number	SET Price
Rigid Coolant-Thru: 3/4" Straight Shank w/ 10 Quick Change Adapters WE1-ANSI	BZ-117623-IN	\$395.00
Rigid Coolant-Thru: 3/4" Straight Shank w/ 10 Quick Change Adapters WE1-KP-ANSI	BZ-117623-KPIN	\$545.00
Rigid Coolant-Thru: 1" Straight Shank w/ 10 Quick Change Adapters WE1-ANSI	BZ-117624-IN	\$395.00
Rigid Coolant-Thru: 1" Straight Shank w/ 10 Quick Change Adapters WE1-KP-ANSI	BZ-117624-KPIN	\$545.00
Tension/Compression: 1" Straight Shank w/ 10 Quick Change Adapters WE1-ANSI	BZ-120298-IN	\$495.00
Tension Only: 1" Straight Shank w/ 10 Quick Change Adapters WE1-ANSI	BZ-120486-IN	\$495.00

Call Us Today For All Of Your Machine Tool Needs!